



NIC FAX UNIT TYPE410

Operating Instructions



-
- 1** Introduction
 - 2** Getting Started
 - 3** Using Scan to E-mail Functions
 - 4** Using Internet Fax Functions
 - 5** Using IP-Fax Functions
 - 6** Using LAN-Fax Functions
 - 7** Using Network Delivery Scanner Functions
 - 8** Registering Addresses
 - 9** Making Settings through a Web Browser
 - 10** Troubleshooting
 - 11** Appendix

Introduction

Thank you for purchasing NIC FAX. This manual contains important information you need to know in order to get the most out of the powerful features and functions of this product. Be sure to read it carefully, and keep it on hand for future reference. Note that you are authorized to use this manual and NIC FAX Driver and Utilities only after you agree to the terms and conditions of the User License Agreement.

- This manual covers NIC FAX operation on a Local Area Network (LAN).
- NIC FAX UNIT TYPE410 is required in order to use the Internet Fax Features.
- Installation of NIC FAX UNIT TYPE410 should be performed by an authorized service provider. Do not attempt installation on your own.

For simplicity, fax machines equipped with NIC FAX UNIT TYPE410 are referred to throughout this manual as NIC FAX.

The contents of this manual assume that you are already familiar with Windows functions and procedures. If you are not, see the documentation that comes with Windows for details on use.

Notes:

Some illustrations in this manual might be slightly different from the machine.

Certain options might not be available in some countries. For details, please contact your local dealer.

Two kinds of size notation are employed in this manual. With this machine refer to the metric version.

Important

Contents of this manual are subject to change without prior notice. In no event will the company be liable for direct, indirect, special, incidental, or consequential damages as a result of handling or operating the machine.

Trademarks

Microsoft®, Windows®, Windows NT®, Outlook® are registered trademarks of Microsoft Corporation in the United States and/or other countries.

Netscape® is a registered trademark of Netscape Communications Corporation.

Netscape Communicator and Netscape Messaging Server are trademarks of Netscape Communications Corporation.

Ethernet® is a registered trademark of Xerox Corporation.

Other product names used herein are for identification purposes only and might be trademarks of their respective companies. We disclaim any and all rights to those marks.

Note

The proper names of the Windows operation systems are as follows:

- Microsoft® Windows® 95 operating system
- Microsoft® Windows® 98 operating system
- Microsoft® Windows® Millennium Edition (Windows Me)
- Microsoft® Windows NT® Server network operating system version 4.0 network operating system version 4.0
- Microsoft® Windows NT® Workstation operating system version 4.0
- Microsoft® Windows® 2000 Professional
- Microsoft® Windows® 2000 Server
- Microsoft® Windows® XP Professional
- Microsoft® Windows® XP Home Edition
- The product name of Microsoft® Windows Server™ 2003 are as follows:
Microsoft® Windows Server™ 2003 Standard Edition
Microsoft® Windows Server™ 2003 Enterprise Edition
Microsoft® Windows Server™ 2003 Web Edition

TABLE OF CONTENTS

What Do You Want to Do with This Machine?	1
How to Read This Manual	2
Manuals for This Machine	3
NIC FAX Unit Manual (on CD-ROM) (this manual)	3
NIC FAX Unit CD-ROM Manual	3
Basic Features	3
Advanced Features	3
Before You Use This Machine	3

1. Introduction

Scan to E-mail Functions	5
Functions Not Supported by Scan to E-mail	6
Internet Fax Functions	7
Internet Fax Precautions	8
Functions Not Supported by E-mail Transmission	8
Functions Not Supported by E-mail Reception	9
IP-Fax Functions	10
IP-Fax Precautions	11
Functions Not Supported by IP-Fax Transmission	11
LAN-Fax Functions	12
LAN-Fax Precautions	12
Network Delivery Scanner Functions	13
Using ScanRouter V2 Lite Server	14
Using ScanRouter V2 Professional Server	15
Functions Not Supported by Network Delivery Scanner	16
How to Read This Manual	17
Necessary Operation Manuals	18
Overview of Setting Up and Delivering Data	19
Using ScanRouter V2 Lite	19
Using ScanRouter V2 Professional	20
Precautions for Reading Instructions and Online Help	21
Making Settings through a Web Browser	22

2. Getting Started

Control Panel	23
Before Using Network Functions	25
Connecting to a LAN	25
Assigning User Function Keys	25
NIC FAX Initial Settings	28
Network Settings	33
TCP/IP Settings	34
Mail Server Settings	38
Auto Mail RX (Auto Mail Reception)	43
Returning to the Initial Display	43
IP-Fax Parameter Settings	43

Installing the Software.....	46
Auto-run Program.....	46
Quick Install.....	46
Installing the Driver and Utilities Individually	48
LAN-Fax Driver.....	48
SmartDeviceMonitor for Client.....	51
SmartDeviceMonitor for Admin.....	52
DeskTopBinder Lite	53
ScanRouter V2 Lite	54
Software Included on the CD-ROM	55
List of Files	55
LAN-Fax Driver	56
Address Book	56
LAN-Fax Cover Sheet Editor	57
SmartDeviceMonitor for Client	57
SmartDeviceMonitor for Admin	58
DeskTopBinder Lite.....	58
ScanRouter V2 Lite	59
Online Help	60
3. Using Scan to E-mail Functions	
<hr/>	
Scanning a Color Original.....	61
Scanner RGB	66
Scanning a Monochrome Original.....	68
4. Using Internet Fax Functions	
<hr/>	
E-mail Server Settings (by Network Administrator)	73
Mail Server Settings	73
E-mail Servers That Have Been Confirmed to Work.....	73
Transmitting Internet Fax.....	74
Confirming Reception	80
Transmitting Journal by E-mail.....	80
Transfer Request	82
Transfer Request by E-mail	84
Specifying End Receivers.....	86
Receiving Internet Fax.....	88
Auto Mail Reception	88
Manual Mail Reception.....	88
Receiving Transfer Request E-mail	90
Routing Received Documents	91
Transferring Received Documents.....	91
Forwarding Received Documents	92
SMTP Reception	93
Routing Mail Received via SMTP	94
Canceling Transmission of an Internet Fax	96
While the Original is Being Scanned In	96
After the Original Has Been Scanned In	96

5. Using IP-Fax Functions

Transmitting IP-Fax	100
Transmitting by Specifying an IP Address or Host Name	100
Transmitting by Specifying a VoIP Gateway	101
Transmitting by Specifying an Alias Fax Number	103
Canceling Transmission of an IP-Fax	105
While the Original Is Being Scanned In.....	105
After the Original Has Been Scanned In	105

6. Using LAN-Fax Functions

Basic Transmission	107
Address Book	110
Printing and Saving	112
Setting LAN-Fax Properties	114

7. Using Network Delivery Scanner Functions

Delivering Scanned Data	117
Color Original	117
Monochrome Original	118
Specifying Destinations Without Using Quick Dial Keys or Speed Dials	120
Specifying by Groups (Group Code)	120
Specifying by Groups (Quick Dial)	120
Specifying by Redial.....	120
Specifying Using the Number Keys.....	121
Routing Received Fax Documents	122
Setting up ScanRouter V2 Professional.....	122
Fax Document Delivery Settings.....	122
Transmission End Operation.....	126
Transmission Using the Backup File Transmission Feature	129
Temporarily Terminating Fax Document Delivery	131

8. Registering Addresses

Registering Addresses for Scanner	133
Registering/Editing a Destination	133
Checking the Short ID of a Destination	135
Registering Addresses for Internet Faxing	137
Registering/Editing a Destination	137
Registering Addresses for IP-Faxing	141
Registering/Editing a Destination	141
Registering Template Addresses	147
Deleting Template Addresses	148
Registering Template Subjects and Messages	149
Deleting Template Subjects and Messages	151

9. Making Settings through a Web Browser

Connecting from your Computer	153
System Requirements	153
Initial Display	154
Functions You Can Check or Set Up	156
Using Online Help	157

10. Troubleshooting

Error Messages	159
NIC FAX Display Messages	159
Web Browser Initial Display Messages	163
LAN-Fax Operation Messages	164
User Parameters	166

11. Appendix

Reports and Lists	171
Transfer Result Report	171
Error Mail Notification	172
Error Report (Mail)	173
Server-Generated Error E-mail	173
Journal	173
Box List	176
Communication Result Report	176
LAN-Fax Error Report	178
Journal by E-mail	179
Specifications	181
Received Images	183
INDEX	184

What Do You Want to Do with This Machine?

This is the summary of this machine's features showing which page you have to read for detailed information.

I Want...	Reference
to change the interval time for automatic e-mail reception	p.40 "Mail RX Interval (Mail Reception Interval)"
to block out unwanted e-mail	p.42 "Auth. E-Mail RX (Authorized E-mail Reception)"
to scan a colored document and send it to computers (Optional)	p.61 "Scanning a Color Original"
to adjust the color balance for color scanning (Optional)	p.66 "Scanner RGB"
to send scanned documents as e-mail	p.68 "Scanning a Monochrome Original"
to send fax via the Internet	p.73 "Using Internet Fax Functions"
to keep the history of incoming and outgoing faxes and e-mail automatically	p.80 "Transmitting Journal by E-mail"
to check incoming e-mail immediately	p.88 "Receiving Internet Fax"
to route documents sent with a SUB code to my computer through NIC FAX using an e-mail address	p.91 "Routing Received Documents"
to route all documents sent without a SUB code to the specified e-mail address	p.91 "Routing Received Documents"
to transfer specified senders' fax to my computer using an e-mail address	p.91 "Transferring Received Documents"
to receive faxes on computer and not to print out them on fax machine	p.92 "Forwarding Received Documents"
to receive e-mail with SMTP reception	p.93 "SMTP Reception"
to receive faxes immediately via a network	p.99 "Using IP-Fax Functions"
to fax documents created with computer applications	p.107 "Using LAN-Fax Functions"
to edit Address Book of LAN-Fax	p.110 "Address Book"
to print documents created with computer applications for proof checking	p.112 "Printing and Saving"
to route scanned documents via network	p.117 "Delivering Scanned Data"
to register frequently-used addresses, subjects and messages	p.147 "Registering Template Addresses" p.149 "Registering Template Subjects and Messages"

How to Read This Manual

Symbols

The following set of symbols is used in this manual.

WARNING:

This symbol indicates a potentially hazardous situation that might result in death or serious injury when you misuse the machine without following the instructions under this symbol. Be sure to read the instructions, all of which are described in the Safety Information section in the Basic Features manual.

CAUTION:

This symbol indicates a potentially hazardous situation that might result in minor or moderate injury or property damage that does not involve personal injury when you misuse the machine without following the instructions under this symbol. Be sure to read the instructions, all of which are described in the Safety Information section in the Basic Features manual.

* The statements above are notes for your safety.

Important

If this instruction is not followed, paper might be misfed, originals might be damaged, or data might be lost. Be sure to read this.

Preparation

This symbol indicates information or preparations required prior to operating.

Note

This symbol indicates precautions for operation, or actions to take after abnormal operation.

Limitation

This symbol indicates numerical limits, functions that cannot be used together, or conditions in which a particular function cannot be used.

Reference

This symbol indicates a reference.

[]

Keys built into the control panel of the machine.

[]

Keys and buttons that appear on the computer's display.

Manuals for This Machine

Five Facsimile Reference manuals are provided, the Basic Features manual, the Advanced Features manual, Before You Use This Machine manual, the NIC FAX Unit manual, and the NIC FAX Unit CD-ROM manual. Please refer to the manual that suits your needs.

NIC FAX Unit Manual (on CD-ROM) (this manual)

Explains about the Scanner function, Internet Fax function, IP-Fax function, and LAN-Fax function.

NIC FAX Unit CD-ROM Manual

Introduces the contents of the NIC FAX CD-ROM and the necessary operating environment for the CD-ROM.

How to access the NIC FAX Unit manual in PDF file on the CD-ROM is also explained.

Basic Features

Explains the most frequently used fax functions and operations.

Advanced Features

Describes more advanced functions, and also explains settings for key operators.

Before You Use This Machine

Explains how to set up your machine.

1. Introduction

Scan to E-mail Functions

There are two types of scanner related functions Scan to E-mail and Network Delivery Scanner. This section describes about the Scan to E-mail function. For details about the Network Delivery Scanner function, see p.13 “Network Delivery Scanner Functions”.

Scanned documents are sent as e-mail messages with an attached image. Black and white documents are converted into PDF or TIFF-F, and color documents into PDF or JPEG images. You can specify a document format with user parameters. Also you can turn the JPEG function on and off with a user function key for Color Scanning.

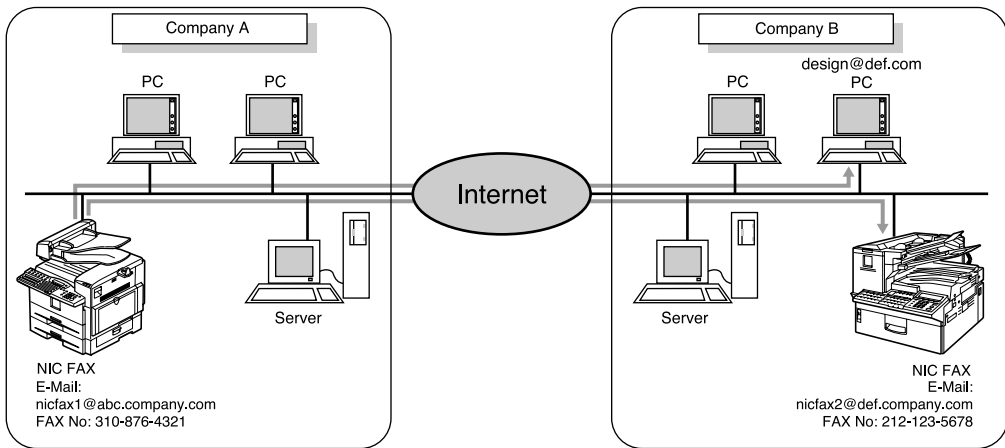

Note

- To send color originals, you need optional color unit.
- When you send e-mail with PDF or JPEG images to NIC FAX using the Scan to E-mail function, NIC FAX cannot receive the e-mail.

Functions Not Supported by Scan to E-mail

1

The following functions are supported with standard fax transmission and reception, but not with Scan to E-mail transmission.

- Immediate Transmission for monochrome originals, Memory Transmission for color originals
- Confidential Transmission
- SUB Code Transmission
- SEP Code Polling Reception
- Polling Transmission
- Polling Reception
- Transfer Request Transmission
- Fax Header
- Label Insertion
- Dialing with the Dial Option Key
- Chain Dial
- On Hook Dial
- Manual Dial
- JBIG Transmission
- Batch Transmission
- ECM (Error Correction Mode)
- Memory File Transfer

Internet Fax Functions

NIC FAX converts scanned document images to e-mail format and transmits the data over the Internet.

The e-mail sent by NIC FAX can be received by another NIC FAX or a computer. Instead of dialing the telephone number of the destination you want to send to, you enter the relevant e-mail address.

Documents are sent as e-mail messages with an attached TIFF-F image. Because of this, a MIME-compatible e-mail reader is required in order to view documents received on a computer. To view an attached image, software capable of displaying TIFF-F formatted images is required. NIC FAX includes DeskTopBinder Lite, which can be used to view, edit, and store image data.

You can also receive e-mail messages from computers or other Internet fax machines, and print or forward these.

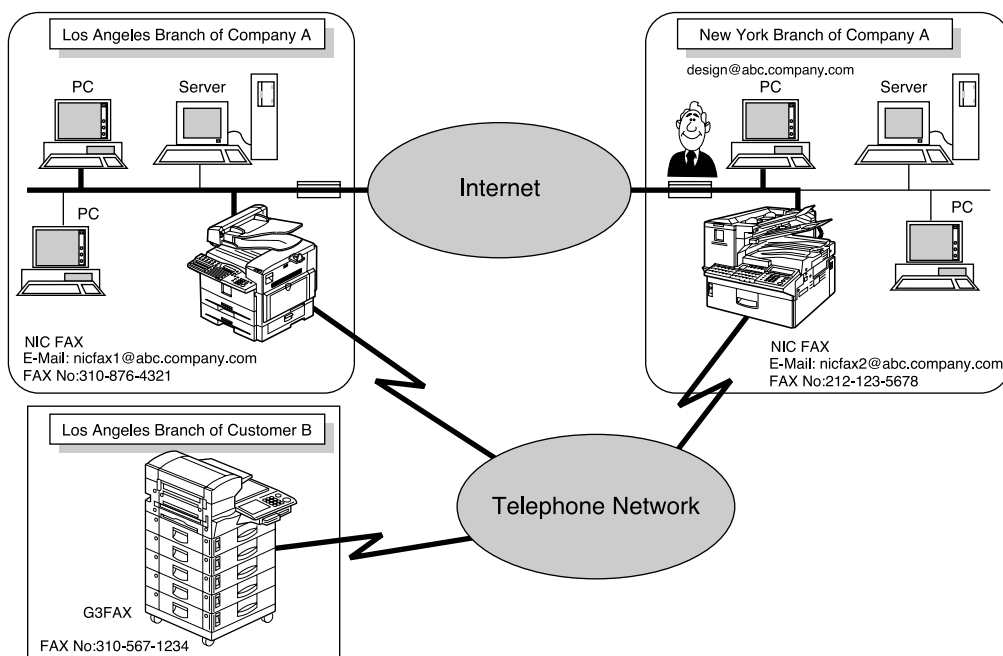

GFINFX0E

Note

- ❑ NIC FAX must be connected to a LAN and set up correctly in order to use its Internet fax functions. See p.23 "Getting Started".
- ❑ The Internet Fax function supported by NIC FAX is compliant with ITU-T Rec. T.37.

Internet Fax Precautions

- Internet Fax communicates with a server over a LAN. It cannot communicate directly with other parties.
- If a transmission is not successful, NIC FAX usually receives an e-mail error notification. However, e-mail error notifications may not be transmitted for various reasons. We recommend you confirm receipt of important e-mail by calling the other party.
- The level of security for Internet communications is low. We recommend you use the telephone network for confidential communications.
- Voice communication is not supported over a LAN.
- Internet fax delivery might be delayed due to network congestion. Use a standard fax whenever communication is time sensitive.

Functions Not Supported by E-mail Transmission

The following functions are supported with standard fax transmission, but not with Internet faxing.

- Immediate Transmission
- Confidential Transmission
- SUB Code Transmission
- ID Transmission
- Polling Transmission
- Chain Dial
- Dialing with the Dial Option Key
- On Hook Dial
- Manual Dial
- JBIG Transmission
- Batch Transmission
- ECM (Error Correction Mode)
- Memory File Transfer

Functions Not Supported by E-mail Reception

The following functions are supported with standard fax reception, but not with Internet faxing.

- ID Reception
- Confidential Reception
- Memory Lock Reception
- Polling Reception
- SEP Code Polling Reception
- Authorized Reception
- Multi-copy Reception
- Specified Tray (optional paper tray required)

IP-Fax Functions

1

With the IP-Fax feature, you can send or receive faxes through fax machines directly connected to the same network using TCP/IP protocol.

Use the IP address or host name instead of the fax number to specify the destination machine, or use the alias number when using the gatekeeper.

You can also send faxes to G3 fax machines connected to PSTN via the VoIP gateways (with T.38 Function).

No e-mail server is required since NIC FAX communicates with destination fax machines connected to the same network directly. The transmission speed is higher than when using G3.

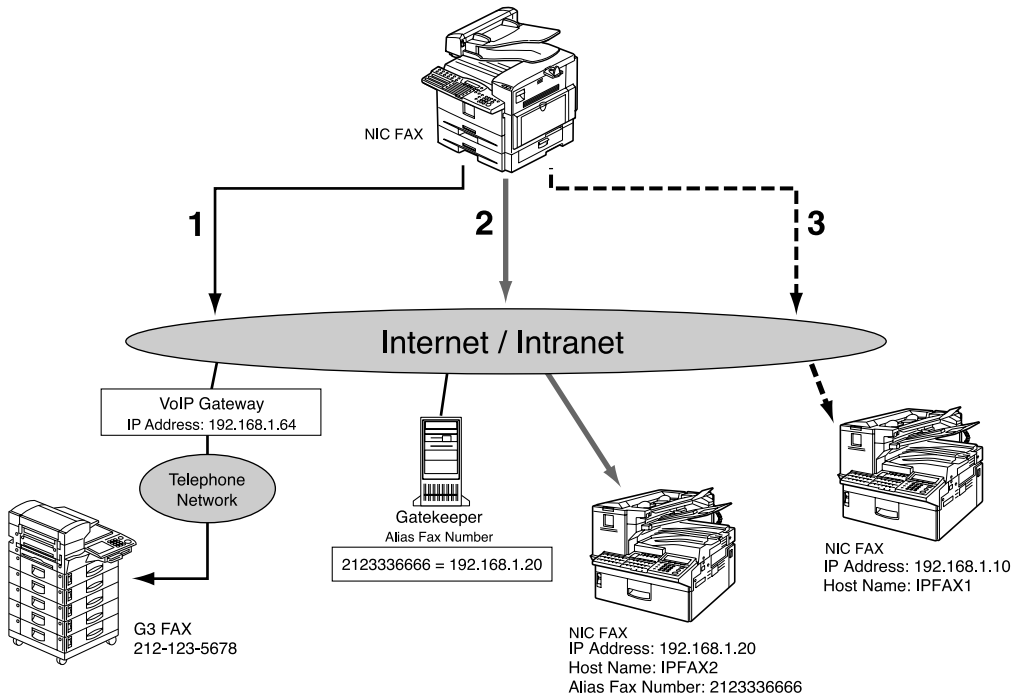

GFIPFX0E

1. Transmission by specifying the destination with the IP address of VoIP gateway (192.168.1.64) and fax number of the receiver (212–123–5678)

2. Transmission by specifying the destination with the alias fax number of the receiver (2123336666)

3. Transmission by specifying the destination with the IP address or host name of the receiver (192.168.1.10 or IPFAX1)

Note

- ❑ NIC FAX must be connected to a LAN and set up correctly in order to use its IP-Fax functions. See p.23 "Getting Started".
- ❑ The IP-Fax function supported by NIC FAX is compliant to ITU-T Rec. T.38.

 **Glossary****❖ Gatekeeper**

This is a device that manages equipment connected to an IP network by converting and authenticating addresses.

❖ VoIP (Voice over Internet Protocol)

This is a technology that enables voice communications over the Internet by linking telephone network and IP network. VoIP gateway converts protocols to connect these different types of networks.

IP-Fax Precautions

- You cannot transmit any data to other networks where a firewall is installed.
 - The level of security for Internet communications is low. We recommend use of the telephone network for confidential communications.
 - Voice communications are not supported over a LAN.
-

Functions Not Supported by IP-Fax Transmission

The following functions are supported with standard fax transmission, but not with IP-Fax transmission.

- Batch Transmission
- Memory File Transfer
- Manual Dial

LAN-Fax Functions

1

With a NIC FAX connected to a LAN, you can use a telephone line to send a fax created using a computer application to another fax machine.

To send a fax, simply select **[Print]** from the Windows application, and then select LAN-Fax as the printer and specify a destination.

In addition to sending faxes, LAN-Fax allows NIC FAX to be used for printing out and saving documents in TIFF-F file for proof checking.

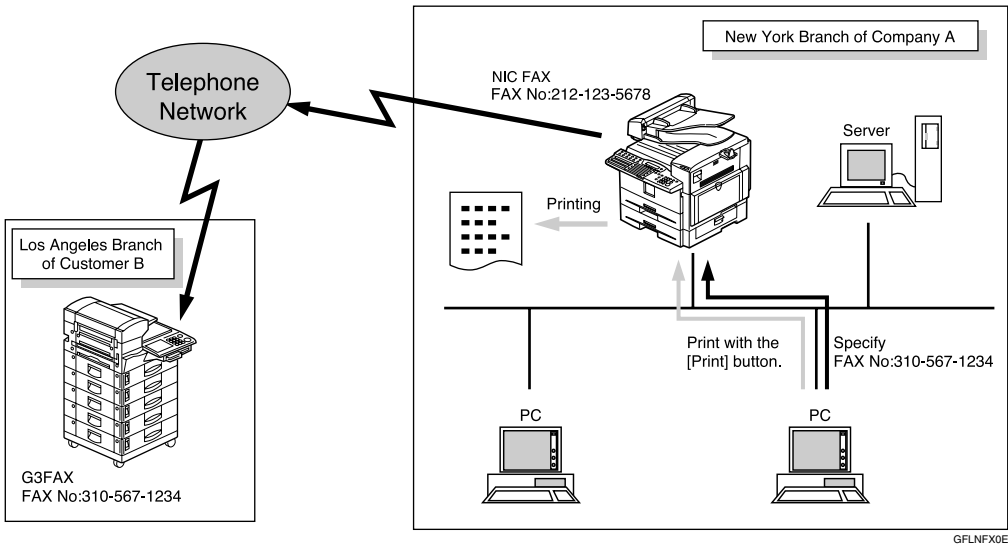

 **Note**

- ❑ NIC FAX must be connected to a LAN and set up correctly in order to use LAN-Fax functions. See p.23 "Getting Started".

LAN-Fax Precautions

- When you transmit faxes, or print documents using the LAN-Fax functions, you cannot abort data transmission by pressing the **[Clear/Stop]** key while the data is being transmitted from your computer to the fax machine.

 **Reference**

- p.107 "Basic Transmission"
- p.112 "Printing and Saving"

Network Delivery Scanner Functions

You can use NIC FAX as a network scanner for ScanRouter V2 Lite/Professional. The documents scanned in by NIC FAX can be saved in the network server or in designated folders on network computers.

Note

- ScanRouter V2 Lite and DeskTopBinder Lite are on the CD-ROM which comes with your NIC FAX.
- ScanRouter V2 Professional is optional. Please contact your service representative if you want to use ScanRouter V2 Professional.
- For brevity, ScanRouter V2 Lite and ScanRouter V2 Professional are referred to throughout this manual as ScanRouter V2 Lite/Professional.
- There is no compatibility between the machine and ScanRouter/ScanRouter Professional. Thus, you cannot transmit documents to ScanRouter or ScanRouter Professional delivery servers.
- This function is available without using e-mail.

Using ScanRouter V2 Lite Server

1

Documents scanned in by NIC FAX are sent to the ScanRouter V2 Lite server.

Sent documents are delivered to or saved in the following locations depending on the setting of ScanRouter V2 Lite server:

- ① ScanRouter V2 Lite server Fax In-Tray
- ② The designated folder on the same network as the ScanRouter V2 Lite server

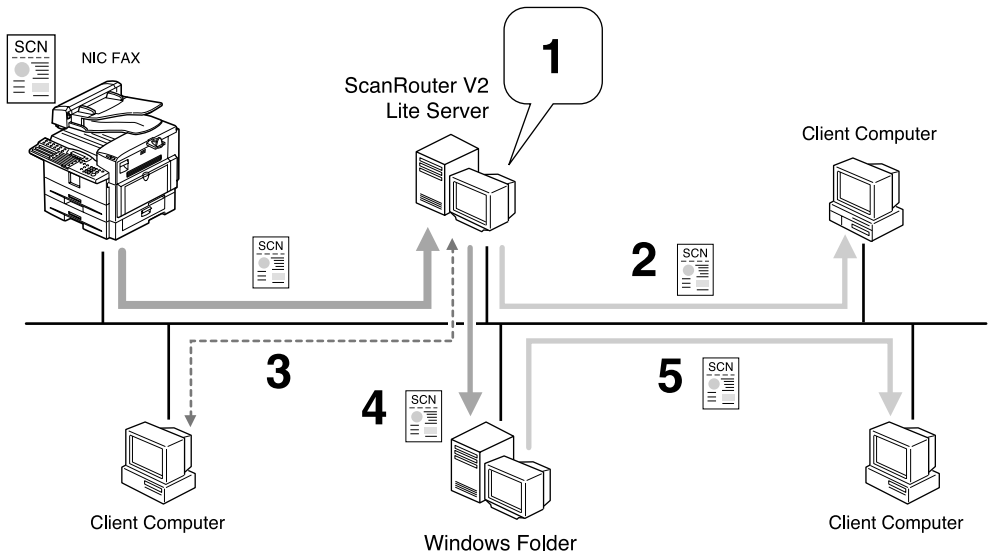

GFLNFX1E

Scanned documents are:

- 1. saved in Fax In-Tray.
- 2. received with ScanRouter V2 Link.
- 3. viewed or picked up by DeskTopBinder Lite.
- 4. delivered.
- 5. shared on network.

Note

- Folders in the other computers as well as in the computer where the ScanRouter V2 Lite Server is installed can be specified as the destination as long as they are connected to the same network as the ScanRouter V2 Lite Server.

Using ScanRouter V2 Professional Server

Documents received from other fax machines or scanned by NIC FAX itself are sent to the ScanRouter V2 Professional server.

Sent documents are delivered to or saved in the following locations depending on the setting of ScanRouter V2 Professional server:

- ① Fax In-Tray in the ScanRouter V2 Professional server
- ② The designated folder on the same network as the ScanRouter V2 Professional server
- ③ The specified e-mail address(es) set on the Fax In-Tray

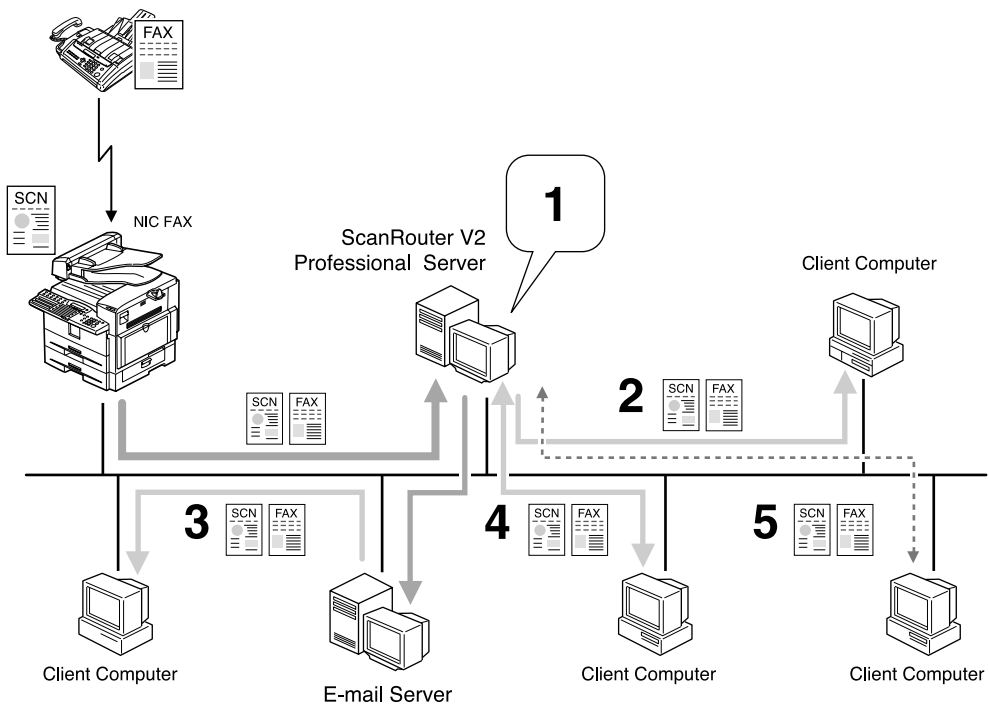

GFLNFX2E

Faxed or scanned documents are:

1. saved as files in Fax In-Tray.
2. received with ScanRouter V2 Link.
3. delivered with e-mail.
4. viewed or downloaded with a Web browser.
5. viewed or picked up with DeskTopBinder Lite.

Note

- You need an e-mail server in order to transmit the scanned documents in e-mail format.
- Folders in the other computers as well as in the computer where ScanRouter V2 Professional Server is installed can be specified as the destination as long as they are connected to the same network as the ScanRouter V2 Professional Server.

Functions Not Supported by Network Delivery Scanner

1

The following functions are supported with standard fax transmission and reception, but not with Network Delivery Scanner.

- Immediate Transmission for monochrome originals, Memory Transmission for color originals
- Confidential Transmission
- SUB Code Transmission
- SEP Code Polling Reception
- Polling Transmission
- Polling Reception
- Transfer Request Transmission
- Fax Header
- Label Insertion
- Dialing with the Dial Option Key
- Chain Dial
- On Hook Dial
- Manual Dial
- JBIG Transmission
- Batch Transmission
- ECM (Error Correction Mode)
- Memory File Transfer

How to Read This Manual

This manual describes the Network Delivery Scanner function that uses ScanRouter V2 Lite/Professional. Note that descriptions in some of the sections are applicable to both applications, and descriptions in other sections are applicable only to particular applications.

Refer to the table below to find the sections that contain the information about the applications you want to use.

Page Number in This Manual	ScanRouter V2 Lite	ScanRouter V2 Professional	Contents
p.117 "Delivering Scanned Data" p.120 "Specifying Destinations Without Using Quick Dial Keys or Speed Dials" p.133 "Registering Addresses for Scanner"	Applicable	Applicable	Describes the procedure for delivering scanned documents or registering a destination. These procedures are the same for both (ScanRouter V2 Lite/Professional).
p.122 "Routing Received Fax Documents"	Not Applicable	Applicable	Provides additional information about ScanRouter V2 Professional not included in the instructions that come with the application. Read this section before you use ScanRouter V2 Professional.
p.159 "NIC FAX Display Messages" (Messages regarding the Network Scanner function only) p.162 "While Using the Network Delivery Scanner Function"	Applicable	Applicable	Provides information that is common to all (ScanRouter V2 Lite/Professional). Read this section as required.

Necessary Operation Manuals

Several other operation manuals are provided other than this that are necessary for using ScanRouter V2 Lite/Professional. Refer to the table below to find additional instructions that are necessary to you.

◆ When Using ScanRouter V2 Lite

Basic Features manual/Advanced Features manual	The Basic Features manual explains the most frequently used fax functions and operations. The Advanced Features manual describes more advanced functions as well as settings for key operators.
ScanRouter V2 Lite Setup Guide ^{*1} ScanRouter V2 Lite Management Guide ^{*2}	ScanRouter V2 Lite Setup Guide describes the setup procedure for ScanRouter V2 Lite. ScanRouter V2 Lite Management Guide describes operations the Administrator needs to perform for managing and maintaining ScanRouter V2 Lite.

^{*1} An operation manual in PDF file that is displayed when you install ScanRouter V2 Lite

^{*2} An operation manual in PDF file that is registered to the Start Menu when you install ScanRouter V2 Lite

◆ When Using ScanRouter V2 Professional

Basic Features manual/Advanced Features manual	The Basic Features manual explains the most frequently used fax functions and operations. The Advanced Features manual describes more advanced functions as well as settings for key operators.
ScanRouter V2 Professional Setup Guide ^{*1} ScanRouter V2 Professional Management Guide ^{*2} ScanRouter V2 Professional Web Document Viewer Setup Guide ^{*2}	ScanRouter V2 Professional Setup Guide describes the setup procedure for ScanRouter V2 Professional. ScanRouter V2 Professional Management Guide describes the operation the Administrator needs to perform for managing and maintaining ScanRouter V2 Professional. ScanRouter V2 Professional Web Document Viewer Setup Guide describes the setup procedure for the server.

^{*1} An operation manual in PDF file that is displayed when you install ScanRouter V2 Professional

^{*2} An operation manual in PDF file that is registered to the Start Menu when you install ScanRouter V2 Professional

Overview of Setting Up and Delivering Data

In order to deliver data to designated server or fax machines, you need to set up NIC FAX and the server correctly. First, follow the steps described below before delivering data. Note that you need to register NIC FAX by I/O device settings for ScanRouter V2 Lite/Professional.

1

Using ScanRouter V2 Lite

Preparation

You need to complete "Network" settings beforehand. Also, set NIC FAX to use ScanRouter V2 Lite with user parameters. See p.166 "User Parameters" (switch 16, bit 2).

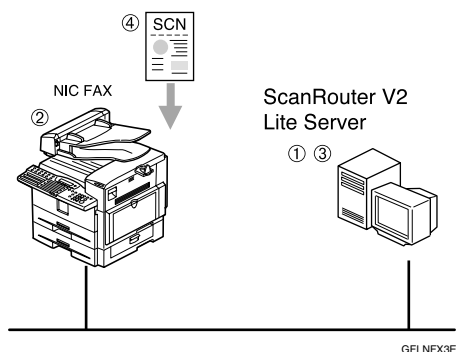

- ① Install ScanRouter V2 Lite from the CD-ROM that comes with NIC FAX. See *ScanRouter V2 Lite Setup Guide*.
- ② Register the IP address or the host name of the ScanRouter V2 Lite server with NIC FAX, and then assign the Scanner (Scan to E-mail) function to a user function key. The Scanner (Scan to E-mail) function is pre-assigned to the **[F10]** key. See p.42 "Scanner Server", p.25 "Assigning User Function Keys", and Chapter 6 "User Function Keys", *Advanced Features*.
- ③ Adjust necessary settings in the computer where ScanRouter V2 Lite is installed, and then set up destinations. See *ScanRouter V2 Lite Management Guide*.
- ④ Transmit the data from NIC FAX. See p.117 "Delivering Scanned Data".

Using ScanRouter V2 Professional

1 Preparation

You need to adjust "Network" settings beforehand. Also, you need to contact your service representative for the setup.

- ① Read precautions to use ScanRouter V2 Professional with NIC FAX. See p.122 "Setting up ScanRouter V2 Professional".

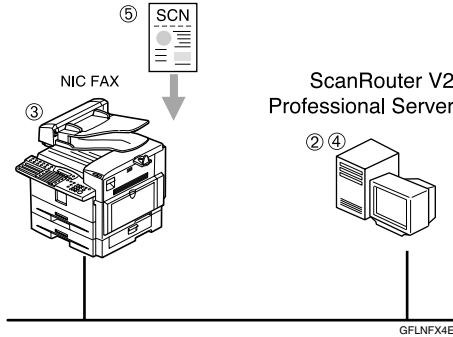

- ② Install ScanRouter V2 Professional on the computer server. See *ScanRouter V2 Professional Setup Guide*.
- ③ Register the IP address or the host name of the ScanRouter V2 Professional server with NIC FAX, and then assign the Scanner (Scan to E-mail) function to a user function key. The Scanner (Scan to E-mail) function is pre-assigned to the **[F10]** key. See p.42 "Scanner Server", p.25 "Assigning User Function Keys", and Chapter 6 "User Function Keys", *Advanced Features*.
- ④ Adjust necessary settings in the computer where ScanRouter V2 Professional is installed, and then set up destinations. See *ScanRouter V2 Professional Management Guide*.
- ⑤ Transmit the data from NIC FAX. See p.117 "Delivering Scanned Data".

Precautions for Reading Instructions and Online Help

When using ScanRouter V2 Lite/Professional with NIC FAX, some specifications differ from those described in the ScanRouter V2 Lite Management Guide stored in NIC FAX Unit CD-ROM and the Operating Instructions and Help are provided with ScanRouter V2 Professional.

Specification differences are described below.

Function	Specification difference	ScanRouter V2 Lite	ScanRouter V2 Professional
Fax document delivery setup	NIC FAX forwards incoming faxes to ScanRouter V2 Professional via the network, thus omit the procedure described under "For a Device for Fax Delivery using RS232" in the ScanRouter V2 Professional Setup Guide.	—	Applied
Fax document delivery	<ul style="list-style-type: none"> • You need to adjust the necessary settings of NIC FAX in order to use the Fax Delivery function, in addition to the settings of ScanRouter V2 Professional. • To specify the destination of the Fax Document Delivery using Fax Delivering ID, SUB codes are used. <p>! Limitation</p> <ul style="list-style-type: none"> <input type="checkbox"/> Confidential Transmission (ID Override) is not available. <p>See p.122 "Fax Document Delivery Settings" for details.</p>	—	Applied
Sender's information	Since NIC FAX cannot specify the sender when transmitting the data using the Network Deliver Scanner function, the sender's information is not included in the mail header.	Applied	Applied
Display order of the users/groups	Since user/group information is not shown on NIC FAX display when specifying the destination, even if you attempt to change the order of the users/groups in the server, the change will not be reflected.	Applied	Applied
Fax port settings	You cannot assign different actions to each fax port.	Applied	Applied

Making Settings through a Web Browser

1

Using a Web browser on your computer connected to a network, you can check the condition of fax communications as well as make changes to settings.

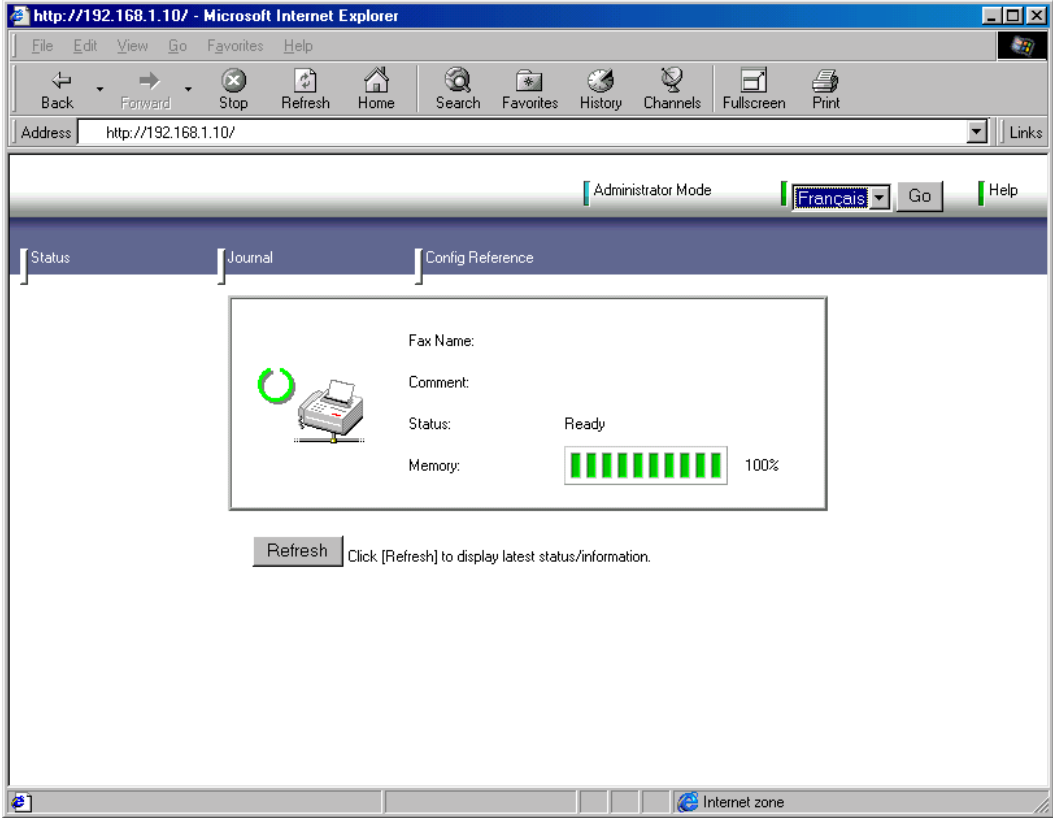

Note

- ❑ You need to connect NIC FAX to a LAN and make "Network" settings in order to make fax settings through a Web browser. See p.23 "Getting Started".
- ❑ See p.153 "Making Settings through a Web Browser" for information about basic procedures and settings you can make.
- ❑ Use online Help to learn the procedures for making various settings. You need to make settings before using online Help. See p.157 "Using Online Help".

2. Getting Started

Control Panel

This section describes the control panel buttons and indicators that are unique to Scanner, Internet Fax, IP-Fax and functions. See Chapter 1 "Control Panel", *Basic Features* for details on other control panel buttons and indicators.

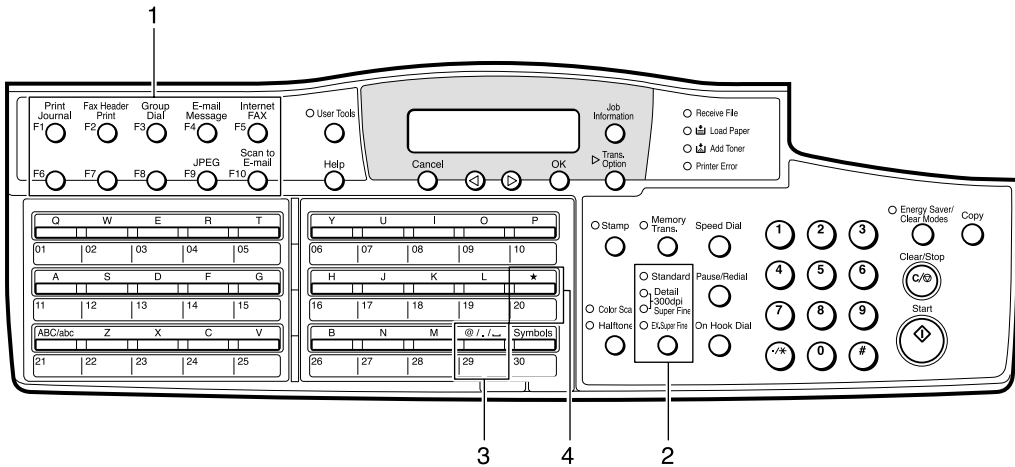

ZHMS270E

1. User Function keys

You can assign the following functions to user function keys according your needs.

- Auto Mail Reception
- Mail Reception
- Mail Options
- E-mail Message
- Internet FAX
- JPEG
- Scanner (Scan to E-mail)

Note

- The E-mail Message function is pre-assigned to the **[F4]** key, Internet FAX function to the **[F5]** key, JPEG function key to the **[F9]** key, and the Scanner (Scan to E-mail) function to the **[F10]** key.

Reference

p.25 "Assigning User Function Keys"

2. Resolution key

Press the Resolution key to toggle the resolutions (Standard, Detail, 300dpi, Super Fine, and Extra Super Fine) depending on how finely you want to transmit documents. See Chapter 2 "Resolution", *Basic Features*.

Note

- When selecting 300dpi, both the Detail and Super Fine indicators are lit.
- To select Extra Super Fine, you need to change the setting with user parameters. See p.166 "User Parameters" (switch 20, bit 2).

3. **[@][.]** Space key (when selecting the QWERTY layout)

You can use "@", ".", and Space to enter e-mail address, IP address, host name or alias fax number. Depending on the key layout, the characters you can enter with Quick Dial keys differ. See Chapter 7 "Key Layout", *Advanced Features*.

 **Note**

- ❑ Characters you can enter using Quick Dial keys differ depending on layout. To set a layout, see Chapter 7 "Key Layout", *Advanced Features*.

4. [★] key

You can register letter strings under this key and extract them entering e-mail addresses, subjects, and messages.

You can register the following letter strings:

- To enter e-mail addresses
By registering strings like ".com" or ".net", you can enter e-mail addresses easily.

 **Reference**

p.147 "Registering Template Addresses"

- To enter subjects and messages of e-mail
By registering subjects and messages you often use beforehand, you can enter them easily.

 **Reference**

p.149 "Registering Template Subjects and Messages"

Before Using Network Functions

Before using network functions, you need to connect the machine to a LAN, and assign necessary functions to the user function keys.

Connecting to a LAN

NIC FAX uses TCP/IP protocol to communicate over a LAN, and must be connected to the LAN with 10BASE-T or 100BASE-TX LAN cable.

❖ 10BASE-T

10BASE-T refers to a twisted pair IEEE802.3 (Ethernet) cable that supports LAN communication at 10 Mbps. Use cables of category 3, 4 or 5 to connect to the machine.

❖ 100BASE-TX

100BASE-TX refers to a twisted pair IEEE802.3u (Ethernet) cable that supports LAN communication at 100 Mbps. Use cables of category 5 to connect to the machine.

Note

- ❑ A LAN cable is not supplied with NIC FAX.

1 Attach the ferrite core.

Loop the cable and attach the ferrite core as shown.

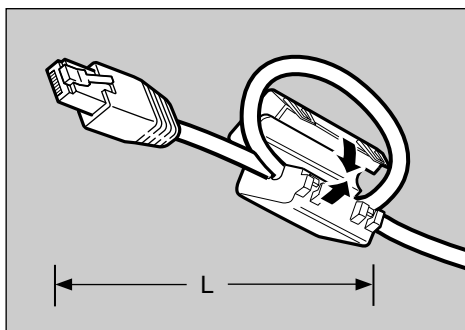

ZHMP120

Note

- ❑ The LAN cable loop should be about 5.1 cm (2 inches) (L) from the end.

2 Connect the cable to the LAN port on the rear of NIC FAX.

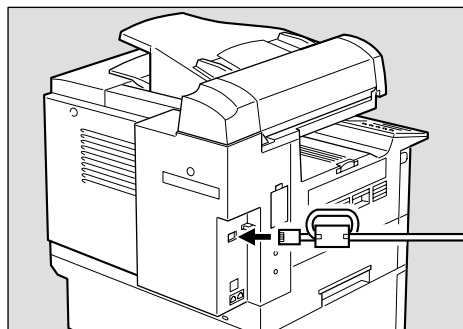

ZHMH360E

3 Plug the other end of the cable into a hub.

Assigning User Function Keys

Assign necessary functions to the user function keys in advance.

❖ Auto Mail Reception

Press the user function key assigned to the Auto Mail Reception function to turn this feature on or off. When the Auto Mail Reception indicator is lit, the server is checked periodically for e-mail, and downloading takes place as necessary. When not lit, e-mail is not received automatically. It is recommended to assign the Auto Mail Reception function to a user function key if you frequently switch the function. See p.88 "Auto Mail Reception".

You also can turn on or off in "Auto Mail RX (Auto Mail Reception)" of the "Network" settings. See p.43 "Auto Mail RX (Auto Mail Reception)".

❖ Mail Reception

Press the user function key assigned to the Mail Reception function to check the e-mail server and receive any new e-mail. Use this key if you do not want to wait for the machine to check the server automatically. This is the same function as "Mail Reception" under **【Job Information】**. It is recommended to assign the Mail Reception function to a user function key if you frequently check e-mail, in addition to Auto Mail Reception. See p.88 "Manual Mail Reception".

❖ Mail Options

You can enter a subject and/or message, and set the Heading, Reception Confirmation and Viewer URL Information function. These are the same functions as "Mail Options" under **【Trans. Option】**.

Reference

p.61 "Using Scan to E-mail Functions"

p.74 "Transmitting Internet Fax"

❖ E-mail Message

You can enter a message by pressing the user function key assigned to the E-mail Message function after entering a subject.

This key also enables you to register subjects/messages on the Template: Subject display.

Note

- The E-mail Message function is pre-assigned to the **【F4】** key.

Reference

p.61 "Using Scan to E-mail Functions"

p.74 "Transmitting Internet Fax"

p.149 "Registering Template Subjects and Messages"

❖ Internet FAX

You need to assign this function when you enter an e-mail address, IP address, host name, or alias fax number.

Pressing the user function key pre-assigned to the Internet FAX function changes the Quick Dial key's function and you can enter alphabets, ". (period)", "@ (at mark)", "- (hyphen)", "_ (under bar)" and other symbols.

Note

- The Internet FAX function is pre-assigned to the **【F5】** key.

❖ JPEG

You can assign this function when you send color documents using the Scanner function. You can select whether you send color documents in JPEG format or not (PDF file) by pressing the user function key assigned to the function. You can also select "JPEG" or "PDF" with user parameters. If you frequently change format, it is recommended you assign the JPEG function to a user function key.

Note

- You need optional color unit to use this feature.
- The JPEG function is pre-assigned to the **【F9】** key.

Reference

p.166 "User Parameters" (switch 17, bit 5)

❖ **Scanner (Scan to E-mail)**

This function must be assigned in order to use Scan to E-mail or Network Delivery Scanner.

To send scanned documents to computers using Scan to E-mail, press the assigned user function key to specify the mail address. To send documents scanned with the Network Delivery Scanner to a ScanRouter V2 Lite server or a ScanRouter V2 Professional server, press the user function key to specify the server-registered destinations.

Note

- The Scanner (Scan to E-mail) function is pre-assigned to the **【F10】** key.
- When a user function key assigned to the Scanner (Scan to E-mail) function is pressed, the "Scanner" display appears.

Reference

See Chapter 6 "User Function Keys", *Advanced Features* for details about how to assign these functions to user function keys.

NIC FAX Initial Settings

NIC FAX settings of the machine include the following items.

❖ How to Read This Table

Required: Setting required

Optional: Setting required in order to use function, or as necessary

—: Setting not required

*1 Items you can acquire from the DHCP server when the Network Boot function is active

*2 Items you cannot set using the Web browser
Other items you can set using the Web browser

❖ TCP/IP settings

Item	Used function							
	Scanner function			Internet Fax function			IP-Fax function	LAN-Fax function
	POP reception of error mail	Scan to E-mail		E-mail transmission	POP reception	SMTP reception		
		SMTP reception of error mail	Network Delivery Scanner					
IP Address *1	Required			Required	Required	Required	Required	Required
Subnet Mask *1	Required			Required	Required	Required	Required	Required
Gateway Address *1	Required			Required	Required	Required	Required	Required
Host Name	Optional	Optional	—	Required	Optional	Required	Optional	Optional
Domain Name *1	Optional	Optional	—	Required	Optional	Required	Optional	—
DNS Address 1 *1	Optional			Optional	Optional	Optional	Optional	Optional
DNS Address 2 *1	Optional			Optional	Optional	Optional	Optional	Optional
Access Control	Optional			Optional	Optional	Optional	Optional	Optional
Access Mask	Optional			Optional	Optional	Optional	Optional	Optional

Item	Used function							
	Scanner function			Internet Fax function			IP-Fax function	LAN-Fax function
	POP reception of error mail	SMTP reception of error mail	Scan to E-mail	Network Delivery Scanner	E-mail transmission	POP reception		
Network Boot	Optional			Optional	Optional	Optional	Optional	Optional
WINS Server Addr. (WINS server address) *1	—			—	—	Optional	Optional	Optional

◆ Mail Server settings

Item	Used function						
	Scanner function			Internet Fax function			
	POP reception of error mail	SMTP reception of error mail	Scan to E-mail	Network Delivery Scanner	E-mail transmission	POP reception	SMTP reception
SMTP Server *1	Required	Required	—	Required	Required	Required	
POP Server *1	Required	—	—	—	Required	—	
Mail Address	Required	Required	—	Required	Required	Required	
Account Name	Required	—	—	Optional	Required	—	
Password	Required	—	—	Optional	Required	—	
Mail RX Interval (Mail reception interval)	Optional	—	—	—	Optional	—	
Time Zone	Required	Required	—	Required	Required	Required	
Mail to Admin. (Mail to administrator)	Optional	Optional	—	Optional	Optional	Optional	

Item	Used function					
	Scanner function			Internet Fax function		
	Scan to E-mail		Network Delivery Scanner	E-mail transmission	POP reception	SMTP reception
	POP reception of error mail	SMTP reception of error mail				
Backup Mail TX (Backup mail transmission)	Optional	Optional	—	Optional	Optional	Optional
Max. Mail Size (Maximum mail size) *2	Optional	—	—	Optional	—	—
Auth. E-Mail RX (Authorized e-mail reception) *2	—	Optional	—	—	—	Optional
Scanner Address	—	—	Required	—	—	—
Template: Subject *2	Optional	Optional	—	Optional	—	—

◆ IP-Fax Parameter settings

Item	Used function
	IP-Fax function
GateKeeper Address	Optional
Own Fax Number (Alias fax number)	Optional

 Note

- After making the settings, print out the list of parameter settings and save it for future reference. See Chapter 7 "How to Set the User Parameters - Printing the User Parameter List", *Advanced Features*.
- To acquire the set values from the DHCP server using the Network Boot function, you need to register the set values on the DHCP server beforehand.
- You can set the reception protocol to IMAP4 with user parameters. IMAP (Internet Message Access Protocol) receives e-mail from the e-mail server. If you receive e-mail from an IMAP4 server, set IMAP4. See p.166 "User Parameters" (switch 17, bit 6).
- Set "Yes" with user parameters beforehand to use the gatekeeper for IP-Fax transmission. See p.166 "User Parameters" (switch 32, bit 0).

Reference

p.93 "SMTP Reception"

p.153 "Making Settings through a Web Browser"

❖ Safer E-mail Transmission and Reception

To transmit and receive e-mail via the Internet with more security, you can use APOP, SMTP authentication, and POP before SMTP for NIC FAX.

Function	Descriptions	Setting
APOP	When you use APOP, passwords are encrypted when e-mail is received. It is safer than POP3 authentication (clear text) which does not encrypt. To use APOP, you need to use a POP server that supports APOP.	Set "Use APOP" to "Yes" with user parameters. See p.166 "User Parameters" (switch 18, bit 1).
SMTP authentication	SMTP authentication (SMTP-AUTH) is an SMTP function that authenticates users to prevent e-mail transmission via unauthorized access to your server. To use the SMTP authentication function, you need to use an SMTP server that supports any of three systems of SMTP authentication (CRAM-MD5, PLAIN, LOGIN). The account name and password specified in the "Mail Server" settings are used for SMTP authentication. Other account names and passwords cannot be specified.	Set "Execute SMTP authentication" to "Yes" with user parameters. See p.166 "User Parameters" (switch 18, bit 2).
POP before SMTP	This function prevents unauthorized access to the SMTP server, and requires users to access and log on the POP server before e-mail transmission.	Set "Access the POP server before accessing the SMTP server at the time of e-mail transmission" to "Yes" with user parameters. See p.166 "User Parameters" (switch 18, bit 6).

If the IMAP server supports AUTHENTICATE command (CRAM-MD5, PLAIN, LOGIN), the user authentication enables logon with more security.

❖ **Network Boot**

Network boot automatically acquires information related to network settings from the network's DHCP server. Setting Network Boot to "DHCP" activates the Network Boot function. See p.37 "Network Boot".

You do not need to set that information on the machine. You can acquire the following information from the DHCP server:

Acquired information	Descriptions	Note
<ul style="list-style-type: none"> • IP Address • Subnet Mask • Gateway Address 	Even if you specify these on the machine, information acquired from the DHCP server is valid.	<ul style="list-style-type: none"> • On the Network setting display, the values you specify on the machine always appear.
<ul style="list-style-type: none"> • Domain Name • DNS Address 1 • DNS Address 2 • WINS Addr. • SMTP Server • POP Server 	If you specify these on the machine, they are valid. If you do not, information acquired from the DHCP server is valid.	<ul style="list-style-type: none"> • The User Parameter List shows both the values you specify on the machine and those the DHCP server acquires. See Chapter 7 "How to Set the User Parameters - Printing User Parameter List", <i>Advanced Features</i>. • You can check currently-valid ones only among values the DHCP server acquires using the Web browser. See p.153 "Making Settings through a Web Browser".

 **Note**

- Servers that have been confirmed to work as DHCP server are Windows NT Server 4.0, and Windows 2000 Server.
- DHCP (Dynamic Host Configuration Protocol) automatically assigns IP addresses and other necessary settings to devices on the network.
- To use a DHCP server, the DHCP server (or DHCP relay agent) has to be installed on the same subnet.
- If the DHCP server cannot assign an IP address, an IP address that is not used on network and begins with "169.254", is automatically selected and used. Then, the NIC FAX periodically accesses the DHCP server to acquire an IP address, and when successful, the IP address is changed to the new one. This is called AutoNet function. While the AutoNet function runs, neither of the Scanner function, Internet Fax function, IP-Fax function and LAN-Fax function can be used.
- When Network Boot is set to "DHCP" and the NIC FAX runs, the IP address of the NIC FAX may be changed. To maintain the DHCP server-assigned IP address, do one of the following:
 - Reserve the NIC FAX IP address (MAC address) you want to use on the DHCP server, so the fixed address is allocated to NIC FAX.
 - Lease the IP address for an indefinite time.

❖ WINS Server

If a WINS server is running, the NIC FAX registers the host name and IP address to the WINS server, and renews them periodically. Computers with the WINS client function allow you to communicate with the NIC FAX using the host name instead of the IP address. To use a WINS server, you need to specify the WINS server address. See p.37 "WINS Server Addr. (WINS Server Address)".

Note

- Servers that have been confirmed to work as WINS server are Windows NT Server 4.0 Service Pack 4 and higher, and Windows 2000 Server.
- WINS (Windows Internet Name Service) associates the IP address allocated to the device on network with the computer name (host name).
- This function searches for NIC FAX using the name from your computer. You cannot inquire the computer name from NIC FAX with the WINS server.
- Only the scope ID allocated by the DHCP server is available.

❖ Other Settings

- To back up incoming and outgoing faxes, see Chapter 3, "Backup File Transmission" and Chapter 7 "Memory File Transfer", *Advanced Features*.
- To specify the SUB code and route documents from NIC FAX to destinations with set user codes, see p.91 "Routing Received Documents".
- To forward received documents to registered destinations based on Own Name, Own Fax Number or sender's e-mail address, see p.92 "Forwarding Received Documents".
- When you send a fax or e-mail specifying the user code, a Communication Result Report is sent to the routing destination's e-mail address. For details, see p.176 "Communication Result Report".

Network Settings

1 Press the **[User Tools]** key.

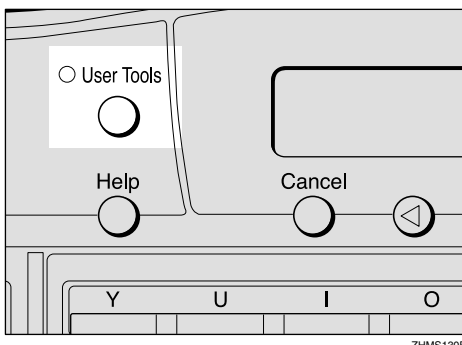

The User Tools main menu appears.

Note

- Make sure the machine shows the standby display. If it does not, see Chapter 1 "Standby Display", *Basic Features* to return to the standby display.

2 Press the **[Left Arrow]** or **[Right Arrow]** key to display "2. Fax Features".



3 Press the **[OK]** key.

- 4** Press the ◀ or ▶ key to display "4. Key Op. Tools".

```
Fax Features:
4.Key Op. Tools
```

- 5** Press the [OK] key.
- 6** Press [2] [2] [2] [2], and then press the [OK] key.
- 7** Press the ◀ or ▶ key to display "15. Network".

```
Key Op. Tools:
15.Network
```

 **Note**

- The number of the function differs depending on the options installed.

- 8** Press the [OK] key.

```
Network:
1.TCP/IP
```

- 9** Press the ◀ or ▶ key to display the item you want to set.

 **Note**

- For further steps, see p.34 "TCP/IP Settings", p.38 "Mail Server Settings", and p.43 "Auto Mail RX (Auto Mail Reception)".

TCP/IP Settings

- 1** Press the ◀ or ▶ key to display "1. TCP/IP".

```
Network:
1.TCP/IP
```

- 2** Press the [OK] key.

```
TCP/IP:
1.IP Address
```

- 3** Press the ◀ or ▶ key to display the item you want to set, and then press the [OK] key.

 **Note**

- If you make a mistake, press the [Cancel] key to try again.

IP Address

Enter the IP address.

The IP (Internet Protocol) address is used by TCP/IP protocol to identify a particular computer.

Consult your systems administrator if you are unsure about this setting.

- 1** Enter the IP address using the number keys.

```
IP Address:  Press OK
[192.168.  1. 10]
```

 **Note**

- Press the ◀ or ▶ key to move the display cursor.
 - If you make a mistake, press the [Clear/Stop] key to try again.
- 2** Press the [OK] key.

The display returns to the TCP/IP settings menu.

Subnet Mask

Enter the subnet mask.

The subnet mask is a group of bits whose value operates on the IP address to separate the network ID portion from the host ID to identify a subnetwork.

Consult your systems administrator if you are unsure about this setting.

- 1 Enter the subnet mask using the number keys.

```
Subnet Mask:  Press OK
[255.255.255.  0]
```

Note

- Press the ⏪ or ⏩ key to move the display cursor.
- If you make a mistake, press the **[Clear/Stop]** key to try again.

- 2 Press the **[OK]** key.

The display returns to the TCP/IP settings menu.

Gateway Address

Enter the default gateway address.

This is the IP address of the router through which connection is made to other networks.

Consult your systems administrator if you are unsure about this setting.

- 1 Enter the gateway address using the number keys.

```
Gateway Address:  /OK
[192.168.  1.  1]
```

Note

- Press the ⏪ or ⏩ key to move the display cursor.

- If you make a mistake, press the **[Clear/Stop]** key to try again.

- 2 Press the **[OK]** key.

The display returns to the TCP/IP settings menu.

Host Name

Enter the host name of NIC FAX.

Consult your systems administrator if you are unsure about this setting.

- 1 Enter the host name.

```
Host Name: [abc] /OK
fax1 [|||||]
```

Note

- You can enter up to 63 characters for a host name.
- To use the WINS server, enter 13 or fewer characters. If you enter 14 or more characters, they are not registered in the WINS server.
- If you make a mistake, press the **[Clear/Stop]** key to try again.

- 2 Press the **[OK]** key.

The display returns to the TCP/IP settings menu.

Domain Name

Enter the domain name of NIC FAX.

Domain name represents the organization you belong to on the Internet.

Consult your systems administrator if you are unsure about this setting.

1 Enter the domain name.

```
Domain Name: [abc] /OK
company.com
```

Note

- You can enter up to 63 characters for a domain name.
- If you make a mistake, press the **[Clear/Stop]** key to try again.

2 Press the [OK] key.

The display returns to the TCP/IP settings menu.

DNS Address 1

Enter the primary DNS server IP address of the network to which NIC FAX is connected.

The DNS server uses DNS (Domain Name System) to manage the computer names (host names) and IP addresses of the computers on the network. When the DNS server is operative, you can find the IP address within the host name.

Consult your systems administrator if you are unsure about this setting.

1 Enter the primary DNS server address using the number keys.

```
DNS Address 1: Press OK
[192.168. 1. 60]
```

Note

- Press the ⏪ or ⏩ key to move the display cursor.
- If you make a mistake, press the **[Clear/Stop]** key to try again.

2 Press the [OK] key.

The display returns to the TCP/IP settings menu.

DNS Address 2

Enter the secondary DNS server IP address of the network to which NIC FAX is connected.

You may set the DNS Address 2 when two domain name systems are connected to your machine. A connection is made to DNS 2 only if DNS 1 does not respond.

Consult your systems administrator if you are unsure about this setting.

1 Enter the secondary DNS server address using the number keys.

```
DNS Address 2: Press OK
[192.168. 1. 61]
```

Note

- Press the ⏪ or ⏩ key to move the display cursor.
- If you make a mistake, press the **[Clear/Stop]** key to try again.

2 Press the [OK] key.

The display returns to the TCP/IP settings menu.

Access Control

Enter the access control setting.

When using the Web browser monitoring function or LAN-Fax function, access control determines the IP address(es) that can connect to NIC FAX.

Consult your systems administrator if you are unsure about this setting. If you do not want to use this feature, leave the setting as "0.0.0.0".

- 1 Enter the Access Control setting using the number keys.

```
Access Control: /OK
[ 0. 0. 0. 0]
```

 **Note**

- Press the ◀ or ▶ key to move the display cursor.
 - If you make a mistake, press the **[Clear/Stop]** key to try again.
- 2 Press the **[OK]** key.

The display returns to the TCP/IP settings menu.

Access Mask

Enter the access mask.

Enter a mask that specifies the range of IP addresses that can be connected based upon the access control setting.

- Example:

```
Access control: 192.168.15.16
Access mask:    255.255.0.0
```

In this case, addresses in the range 192.168.XXX.XXX can connect.

Consult your systems administrator if you are unsure about this setting. If you set this value to "0.0.0.0", Access Control is not available.

- 1 Enter the access mask using the number keys.

```
Access Mask: Press OK
[ 0. 0. 0. 0]
```

 **Note**

- Press the ◀ or ▶ key to move the display cursor.

- If you make a mistake, press the **[Clear/Stop]** key to try again.

- 2 Press the **[OK]** key.

The display returns to the TCP/IP settings menu.

Network Boot

Set the Network Boot setting to "DHCP" if you use the Network Boot function with the DHCP server.

Consult your systems administrator if you are unsure about this setting.

 **Reference**

p.32 "Network Boot"

- 1 Press the ◀ or ▶ key to select "Off" or "DHCP".

```
Network Boot: ◀/OK
Off [DHCP]
```

- 2 Press the **[OK]** key.

The display returns to the TCP/IP settings menu.

WINS Server Addr. (WINS Server Address)

Enter the IP address of the WINS server.

Consult your systems administrator if you are unsure about this setting.

 **Reference**

p.33 "WINS Server"

- 1 Enter the IP address of the WINS server using the number keys.

```
WINS Server Addr.: /OK
[192.168. 1. 68]
```

- 2 Press the **[OK]** key.

The display returns to the TCP/IP settings menu.

Mail Server Settings

- 1 Press the **[Left]** or **[Right]** key to display "2. Mail Server".



- 2 Press the **[OK]** key.



- 3 Press the **[Left]** or **[Right]** key to display the item you want to set, and then press the **[OK]** key.

Note

- If you make a mistake, press the **[Cancel]** key to try again.
- You can enter "." and "@" with the Quick Dial key in each address setting. Pressing the **[Symbols]** key enables entering symbols. Pressing the **[ABC/abc]** key switches between upper cases and lower cases.

SMTP Server

Enter the IP address of the SMTP server.

The SMTP server is the server that delivers e-mail over the Internet.

Consult your systems administrator if you are unsure about this setting.

- 1 Enter the SMTP server address using the number keys.

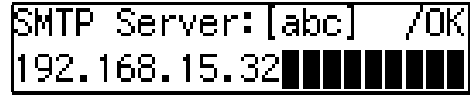

Note

- If you make a mistake, press the **[Clear/Stop]** key to try again.
- The SMTP server can also be specified as a domain. In this case, you must specify the DNS server address beforehand.
- You can enter up to 127 characters for a domain.

- 2 Press the **[OK]** key.

The display returns to the Mail Server settings menu.

POP Server

Enter the IP address of the POP server.

The POP server is the server that receives e-mail over the Internet.

If you use IMAP4 server, specify the IMAP4 address in the following procedure. Also, you need to set IMAP4 with user parameters. See p.166 "User Parameters"(switch 17, bit 6).

Consult your systems administrator if you are unsure about this setting.

- 1 Enter the POP server address using the number keys.

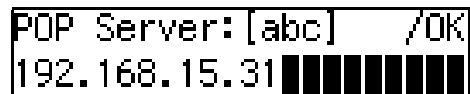

Note

- If you make a mistake, press the **[Clear/Stop]** key to try again.

- The POP server can also be specified as a domain. In this case, you must specify the DNS server address beforehand.
- You can enter up to 127 characters for a domain.

2 Press the [OK] key.

The display returns to the Mail Server settings menu.

Mail Address

Enter the mail address of NIC FAX.

Consult your systems administrator if you are unsure about this setting.

1 Enter the mail address.

```
Mail Address: [abc] /OK
fax1@company.com
```

Note

- You can enter up to 127 characters for a mail address.
- If you make a mistake, press the **[Clear/Stop]** key to try again.

2 Press the [OK] key.

The display returns to the Mail Server settings menu.

Account Name

Enter the account name to be used for connection to the POP server.

Consult your systems administrator if you are unsure about this setting.

1 Enter the account name.

```
Account Name: [abc] /OK
fax1
```

Note

- You can enter up to 31 characters for an account name.
- If you make a mistake, press the **[Clear/Stop]** key to try again.

2 Press the [OK] key.

The display returns to the Mail Server settings menu.

Password

Enter the login password to be used for connection to the POP server.

Consult your systems administrator if you are unsure about this setting.

1 Enter the password.

```
Password: [abc] /OK
*****
```

Note

- You can enter up to 31 characters for a password.
- If you make a mistake, press the **[Clear/Stop]** key to try again.

2 Press the [OK] key.

The display returns to the Mail Server settings menu.

Mail RX Interval (Mail Reception Interval)

When using the Auto Mail Reception function, enter the interval in minutes at which NIC FAX is to automatically check for mail.

- 1 Enter the interval for automatic reception using the number keys.

```
Mail RX Interval: /OK
[ 3] min.        (1-60)
```

 **Note**

- You can enter a value between 1 and 60 minutes in one-minute increments.

- 2 Press the **[OK]** key.

The display returns to the Mail Server settings menu.

Time Zone

Enter the time difference between your time zone and Greenwich Mean Time.

- 1 Press the **◀** or **▶** key to adjust the time difference.

```
Time Zone:      ◀▶/OK
[ 0]hrs        (-12 +12)
```

 **Note**

- The time zone set up in this step appears on the mail header information, thus if the setting is not done correctly, the receivers will not get the correct reception time either.

- 2 Press the **[OK]** key.

The display returns to the Mail Server settings menu.

Mail to Admin. (Mail to Administrator)

Make this setting when you want Error Mail Notifications to be sent to another address, in addition to the originator.

NIC FAX sends an Error Mail Notification and a Transfer Request Notification to the sender and a copy (CC) to the address specified with this setting.

You can also have the Journal sent to address specified with this setting. For more details about the setting, see p.80 "Transmitting Journal by E-mail".

- 1 Enter the address to which notification will be sent if an error occurs.

```
Mail to Admin.: [abc]OK
nicf1@abc.company.com
```

 **Note**

- You can enter up to 127 characters.
- If you make a mistake, press the **◀** or **▶** key to move the display cursor, and then press the **[Clear/Stop]** key to try again.

- 2 Press the **[OK]** key.

The display returns to the Mail Server settings menu.

Backup Mail TX (Backup Mail Transmission)

Make this setting when you want all outgoing e-mail sent by the Internet Fax function and monochrome Scan to E-mail function to be routed to another address in addition to the destination. A blind carbon copy (BCC) of all sent e-mail messages is sent to this address. If you want to back up outgoing faxes, see Chapter 3 "Backup File Transmission", *Advanced Features*.

1 Enter the e-mail backup address.

```
Backup Mail TX: [abc]OK
nicf2@abc.company.com
```

Note

- You can enter up to 127 characters.
- If you make a mistake, press the \leftarrow or \rightarrow key to move the display cursor, and then press the **[Clear/Stop]** key to try again.

2 Press the **[OK]** key.

The display returns to the Mail Server settings menu.

Max. Mail Size (Maximum Mail Size)

Make this setting when you want to limit the size of e-mail messages that are transmitted, if receivers limit e-mail size, or you cannot send large size e-mail for some reason. When this function is set to on, transmission of e-mail that exceeds the set size is aborted.

Limitation

- This function does not work with Backup File Transmission destinations specified on NIC FAX.

Note

- When e-mail exceeds the maximum file size, an Error Report is output, and the e-mail is deleted.
- Even when e-mail does not exceed the size limit, it may be rejected if it does not meet the requirements of the server settings.

1 Press \leftarrow or \rightarrow key to display "1. On/Off".

```
Max. Mail Size:
1. On/Off
```

2 Press the **[OK]** key.

3 Press \leftarrow or \rightarrow key to select "On".

```
Max. Mail Size: ◀/OK
[On] Off
```

Note

- If you do not want to set a maximum e-mail size, press the \leftarrow or \rightarrow key to select "Off".

4 Press the **[OK]** key.

5 Press the \leftarrow or \rightarrow key to display "2. Available Size".

```
Max. Mail Size:
2. Available Size
```

6 Press the **[OK]** key.

7 Enter the file size limit using the number keys.

```
Size: Press OK
[1000]KB (1-9999)
```

Note

- You can set a file size from 1 to 9999 KB.

8 Press the **[OK]** key.

9 Press the **[Cancel]** key.

The display returns to the Mail Server settings menu.

Auth. E-Mail RX (Authorized E-mail Reception)

This function is available on systems that allow routing of mail received via SMTP. See p.94 "Routing Mail Received via SMTP".

When a limit address is set, mail received from addresses that do not match the limit address is discarded, and an error message is returned to the SMTP server.

The limit address is compared with the addresses of mail originators, as illustrated by the following examples.

When the limit address is set to "@nic.fax.com":

- abc@nic.fax.com - accepted
- nic@fax.com - not accepted
- abc@fax.com - not accepted

Note

- No Error Report is output even when e-mail is discarded.

1 Enter the e-mail address for limiting routing.



Note

- You can enter up to 127 characters.

- If you make a mistake, press the ⏪ or ⏩ key to move the display cursor, and then press **[Clear/Stop]** key to try again.

2 Press the **[OK]** key.

The display returns to the Mail Server settings menu.

Scanner Server

Enter the IP address of the delivery server to transmit the scanned documents.

Note

- "Scanner Server" only appears on the display when ScanRouter V2 Lite is selected with user parameters or ScanRouter V2 Professional is set up by the service representative. See p.166 "User Parameters"(switch 16, bit 2).

1 Enter the IP address or domain name of the server.

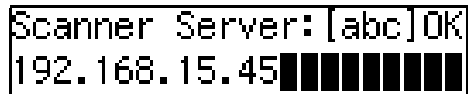

Note

- If you want to enter the server address with a domain name, make sure that the DNS server address is specified in advance.

- You can enter up to 127 characters for a domain name.

2 Press the **[OK]** key.

The display returns to the Mail Server settings menu.

Template: Subject

Register template subjects and/or messages to use them in "Subject/Message" under "Mail Options". In "Subject/Message" under "Mail Options", you can easily extract and enter registered subjects/messages by pressing the **[★]** key.

For details about the setting of "Template: Subject", see p.149 "Registering Template Subjects and Messages"

Auto Mail RX (Auto Mail Reception)

If Auto Mail Reception function is set to "On", the machine automatically receives e-mail according to the Mail Reception Interval setting. See p.40 "Mail RX Interval (Mail Reception Interval)".

Note

- ❑ Set the Auto Mail Reception function to "On" or "Off" by following the procedure below, or assign a user function key to "Auto Mail RX". If you assign a user function key to "Auto Mail RX" beforehand, you can easily switch between "On" and "Off" anytime. See p.23 "Control Panel".

- 1** Press the **[Left]** or **[Right]** key to display "3. Auto Mail RX".

```
Network:
3. Auto Mail RX
```

- 2** Press the **[OK]** key.

- 3** Press the **[Left]** or **[Right]** key to select "On" or "Off".

```
Auto Mail RX:
[On] Off
```

- 4** Press the **[OK]** key.

The display returns to the Network settings menu.

Returning to the Initial Display

- 1** Press the **[User Tools]** key.

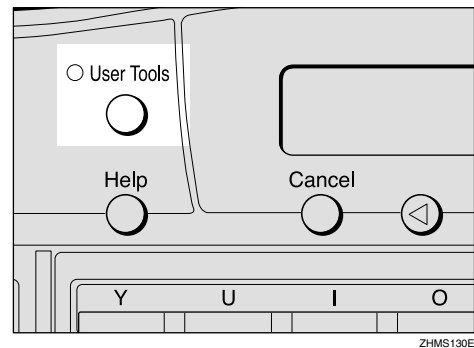

The standby display reappears.

IP-Fax Parameter Settings

Preparation

Select "Yes" with user parameters to use the gatekeeper for IP-Fax transmission. See p.166 "User Parameters" (switch 32, bit 0).

- 1** Press the **[User Tools]** key.

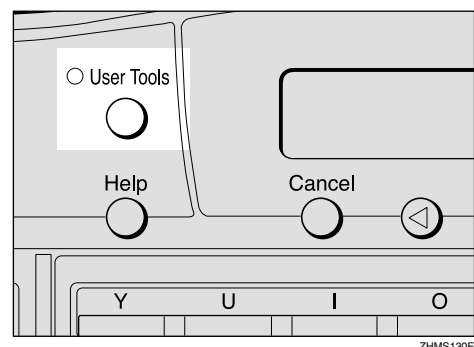

The User Tools main menu appears.

Note

- ❑ Make sure that the machine shows the standby display. If it does not, see Chapter 1 "Stand-by Display", *Basic Features* to return to the standby display.

- 2 Press the ◀ or ▶ key to display "2. Fax Features".

```
User Tools:
2.Fax Features ◀▶
```

- 3 Press the [OK] key.

- 4 Press the ◀ or ▶ key to display "4. Key Op. Tools".

```
Fax Features:
4.Key Op. Tools ◀▶
```

- 5 Press the [OK] key.

- 6 Press [2] [2] [2] [2], and then press the [OK] key.

- 7 Press the ◀ or ▶ key to display "16. IP-Fax Parameter".

```
Key Op. Tools:
16.IP-Fax Parameter ◀▶
```

Note

- ❑ The number of the function differs depending on the options installed.

- 8 Press the [OK] key.

```
IP-Fax Parameter:
1.GateKeeper Address ◀▶
```

- 9 Press ◀ or ▶ to display the item you want to set, and then press the [OK] key.

Gatekeeper Address

Gatekeeper is a server which connects the telephone number and the IP address.

You need to set up the gatekeeper address to use this function.

- 1 Enter the IP address or host name of the gatekeeper.

```
Gatekeep. Add.: [abc]OK
192.168.1.64 ██████████
```

Note

- ❑ If you want to enter the gatekeeper address using the host name, make sure that the DNS server address is specified in advance.
- ❑ You can enter up to 127 characters for a host name.
- ❑ If you make a mistake, press the ◀ or ▶ key to move the display cursor, and then press the [Clear/Stop] key to try again.

- 2 Press the [OK] key.

The display returns to the IP-Fax Parameter settings menu.

Own Fax Number (Alias Fax Number)

Own Fax Number is an alias fax number that represents the IP address in a shortened form; that is a telephone number.

When using gatekeeper, Own Fax Number needs to be specified on NIC FAX.

1 Enter Own Fax Number.

Own Fax No.: Press OK
☎ 2123366666

Note

- You can enter up to 127 digits.
- You can enter digits 0 to 9, "#", and "*".
- If you make a mistake, press the ⏪ or ⏩ key to move the display cursor, and then press the **[Clear/Stop]** key to try again.

2 Press the [OK] key.

The display returns to the IP-Fax Parameter settings menu.

10 Press the [User Tools] key.

The standby display reappears.

Installing the Software

NIC FAX comes with a CD-ROM containing the driver and utilities for LAN-Fax and Network Delivery Scanner functions.

Note

- ❑ This manual assumes users already have a working knowledge of Windows operating systems. Refer to the relevant Windows manual for specific details of Windows functions and operations.

Auto-run Program

When the CD-ROM is loaded, the installer starts automatically (auto-run), allowing easy installation.

Note

- ❑ To install NIC FAX Driver and Utilities on a Windows NT 4.0, Windows 2000, or Windows XP system, you have to be in an Administrators group.
- ❑ Depending on Windows settings, the auto-run program may not start. In such cases, double-click "SETUP.EXE" (located in the CD-ROM's root directory).
- ❑ If you do not want to start the auto-run program, hold down the shift key until your computer loads the CD-ROM and access is complete.
- ❑ If you click [**Cancel**] before installation is complete, the process stops. Restart the installer to complete installation.
- ❑ Screen displays shown in the procedure below may differ depending on versions of Windows, and environment settings.

Quick Install

You can install software easily, using the CD-ROM provided. By simply pressing Quick Install, the following are installed:

- LAN-Fax Driver (Settings for the TCP/IP port are also made.)
- Address Book
- LAN-Fax Cover Sheet Editor
- SmartDeviceMonitor for Client

Note

- ❑ If you have already installed SmartDeviceMonitor for Client, the LAN-Fax function will be ready after installing LAN-Fax Driver. See p.48 "LAN-Fax Driver".

1 Before beginning installation, exit all other applications.

2 Insert the CD-ROM that contains NIC FAX Driver and Utilities into the CD drive on your computer.

The Select Language dialog box appears.

3 Select the language you want, and then click [OK].

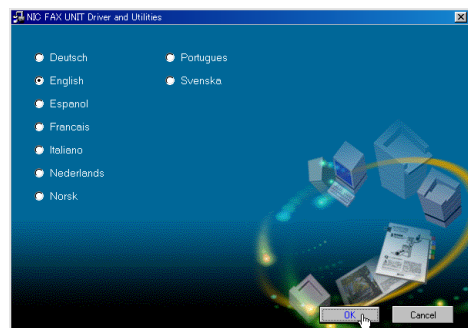

The install program starts.

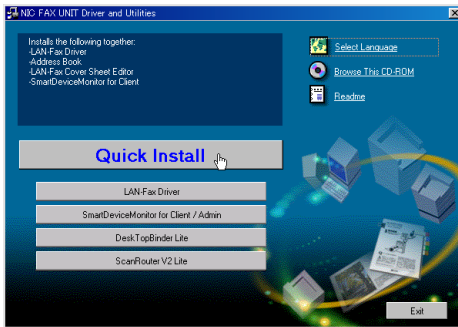
4 Click [Quick Install].

Software License Agreement appears.

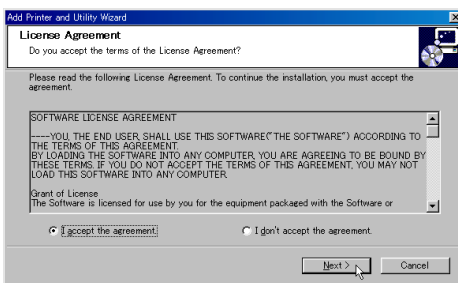
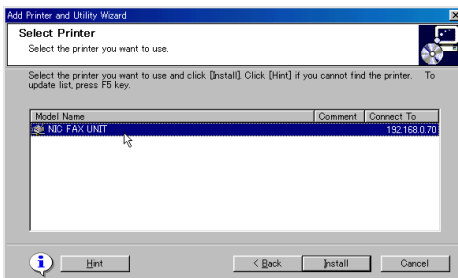
5 Make sure you read it carefully, click [I accept the agreement.], and then click [Next].**6** Click [NIC FAX UNIT].**7** Click [Install].

The following display appears and installation starts.

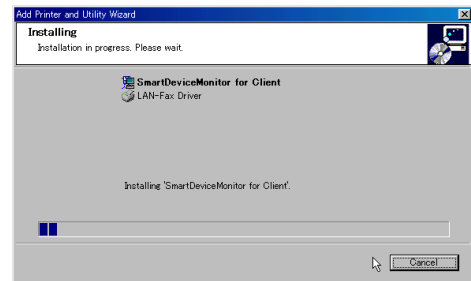

The Installation Completion dialog box appears.

Note

The following display may appear during installation. Click [Yes] for Windows 2000, and [Continue Anyway] for Windows XP to continue the installation.

- Windows 2000

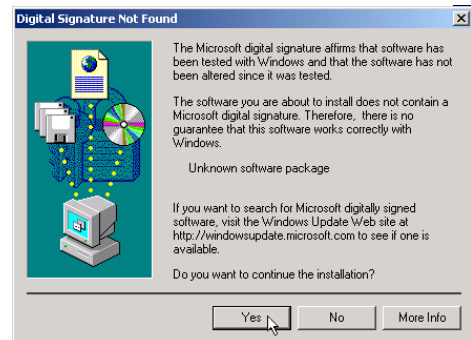

- Windows XP

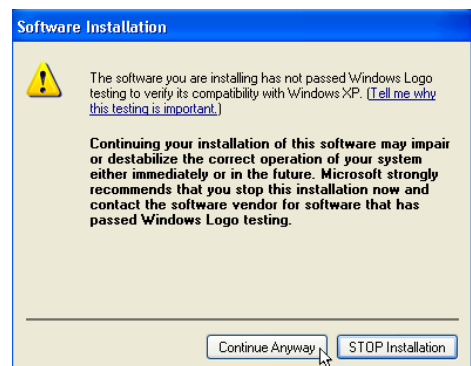

2

8 To restart the computer, click **[Yes. Restart right now.]**

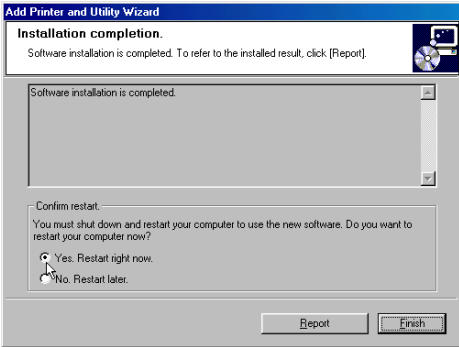

Note

- If you do not want to restart the computer, click **[No. Restart later.]**
- If the **[Confirm restart]** area does not appear, proceed to step **9**.

9 Click **[Finish]**.

If you click **[Yes. Restart right now.]** in the step **8** display, installation completes and the computer restarts.

Note

- If you click **[No. Restart later.]** in the step **8** display, installation completes without restarting the computer. Installed driver and utilities are available only after you restart the computer.
- To edit the printer name, on the **[Start]** menu, point to **[Settings]**, and then click **[Printers]**. Next, right-click the printer icon you want to edit the name of, and then click **[Rename]**.

Installing the Driver and Utilities Individually

LAN-Fax Driver

Note

- You need to install SmartDeviceMonitor for Client before LAN-Fax Drivers. If SmartDeviceMonitor for Client is not installed, follow the steps described in SmartDeviceMonitor for Client. See p.51 "SmartDeviceMonitor for Client".

1 Before beginning installation, exit all other applications.

2 Insert the CD-ROM that contains NIC FAX Driver and Utilities into the CD drive on your computer.

The Select Language dialog box appears.

3 Select the language you want, and then click **[OK]**.

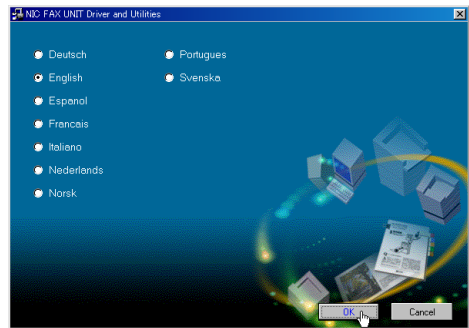

The install program starts.

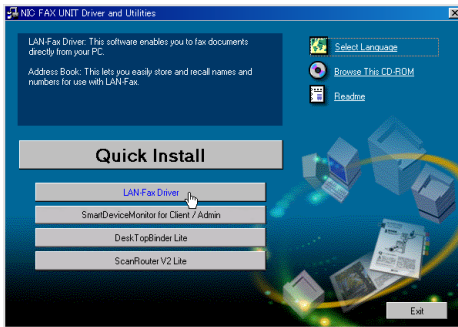
4 Click [LAN-Fax Driver].

[Add Printer and Utility Wizard] starts, and Software License Agreement appears.

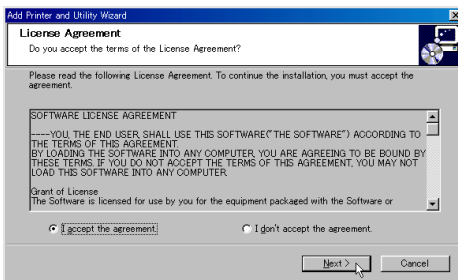
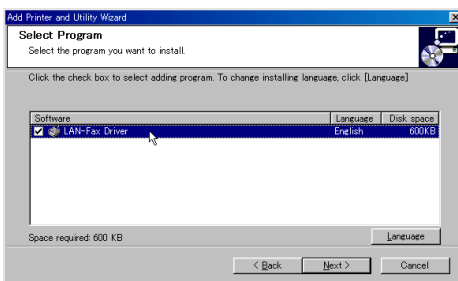
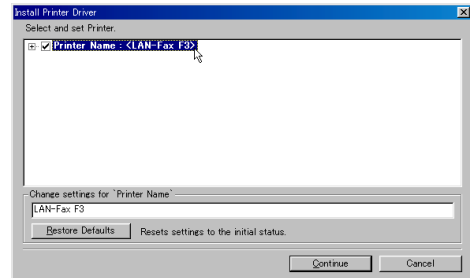
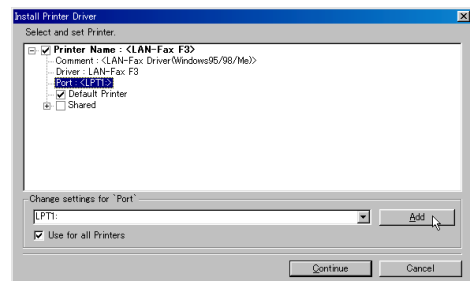
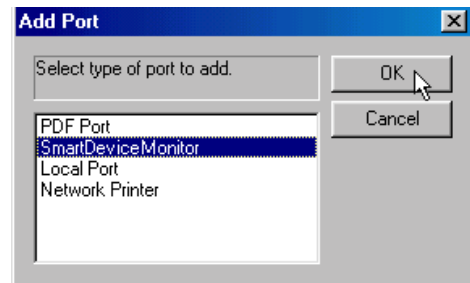
5 Make sure you read it carefully, click [I accept the agreement.], and then click [Next].**6** Click [LAN-Fax Driver].**7** Click [Next].**8** Double-click [Printer Name: <LAN-Fax F3>].**9** Click [Port], and then [Add].**10** Select [SmartDeviceMonitor], and then click [OK].**Note**

- ❑ With Windows 2000 or Windows XP, do not select "Standard TCP/IP Port" as the port for LAN-Fax Driver. If "Standard TCP/IP Port" is specified, error notification will not be sent, even if an error occurs during data transmission from the computer to NIC FAX for LAN-Fax faxing or printing. See p.165 "When Using Standard TCP/IP Port".

11 Click [Specify Address].

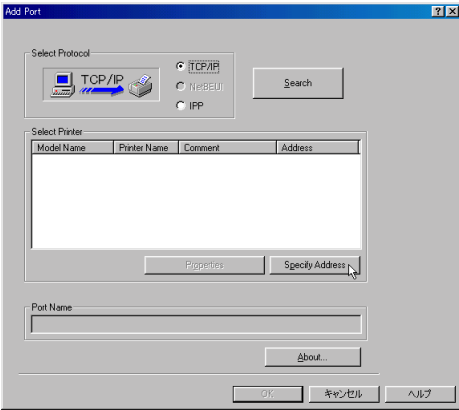

12 Enter the IP address or host name assigned to NIC FAX, and then click [OK].

When entering a host name, first click [Host Name] and then enter the host name in the box to the right.

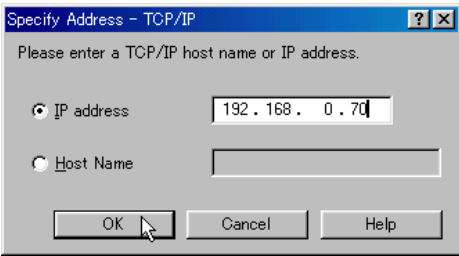

Note

If you use the Network Boot function, specify the host name, as the NIC FAX IP address may change. In this case, you need to make the following settings to search for NIC FAX by host name:

- When you use the DNS server:
The DNS server settings must be made on the computer on which LAN-Fax Driver is being installed.

- When you use the WINS server:
The settings of the WINS server must be made the same as those on the computer on which LAN-Fax Driver is being installed, and NIC FAX.

Reference

p.32 "Network Boot"

p.33 "WINS Server"

13 Check to see if [TCP/IP] is selected and the machine's port name is displayed correctly, and then click [OK].

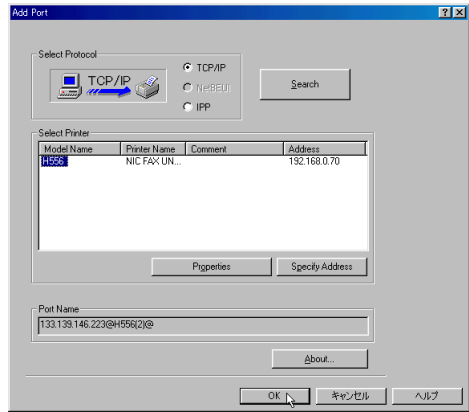

14 Click [Continue].

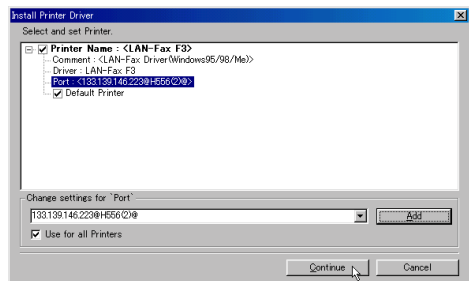

Install starts.

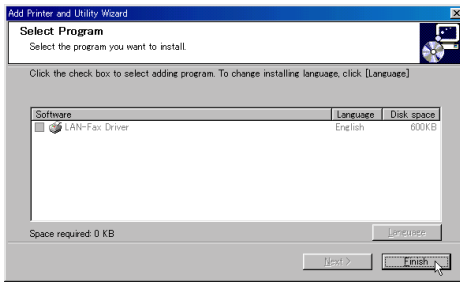
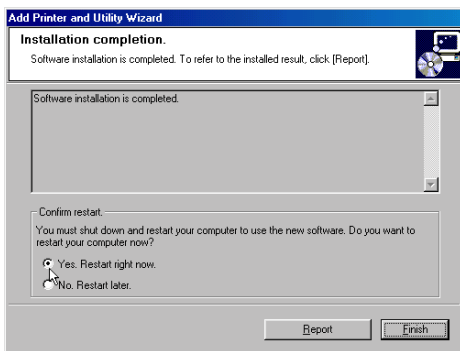
15 Click **[Finish]**.**16** To restart the computer, click **[Yes. Restart right now.]****Note**

- If you do not want to restart the computer, click **[No. Restart later.]**
- If the **[Confirm restart]** area does not appear, proceed to step **17**.

17 Click **[Finish]**.

If you click **[Yes. Restart right now.]** in the step **16** display, installation completes and the computer restarts.

Note

- If you click **[No. Restart later.]** in the step **16** display, installation completes without restarting the computer. Installed driver and utilities are available only after you restart the computer.

- To edit the printer name, on the **[Start]** menu, point to **[Settings]**, and then click **[Printers]**. Next, right-click the printer icon you want to edit the name of, and then click **[Rename]**.

SmartDeviceMonitor for Client

2

1 Before beginning installation, exit all other applications.**2** Insert the CD-ROM that contains NIC FAX Driver and Utilities into the CD drive on your computer.

The Select Language dialog box appears.

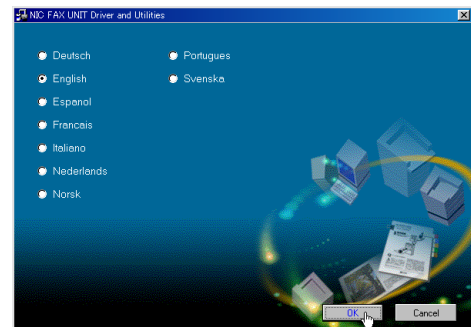
3 Select the language you want, and then click **[OK]**.

The install program starts.

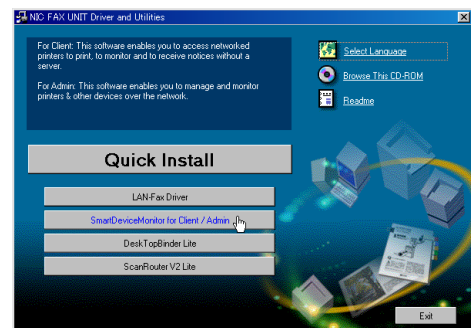
4 Click **[SmartDeviceMonitor for Client / Admin]**.

[Add Printer and Utility Wizard] starts, and Software License Agreement appears.

- 5** Make sure you read it carefully, click [I accept the agreement.], and then click [Next].

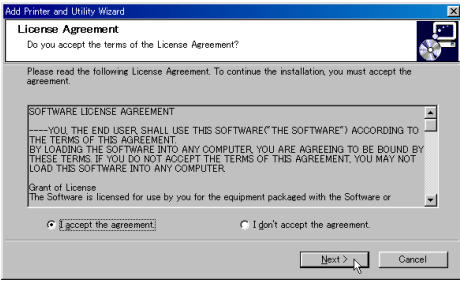

2

- 6** Select the [SmartDeviceMonitor for Client] check box, and then click [Next].

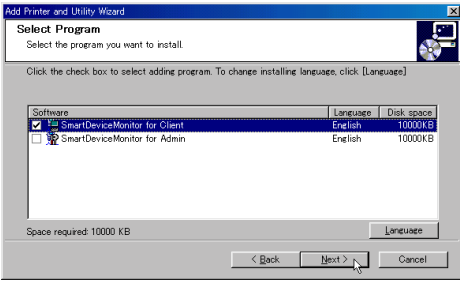

The [Welcome] dialog box appears.

- 7** Click [Next].

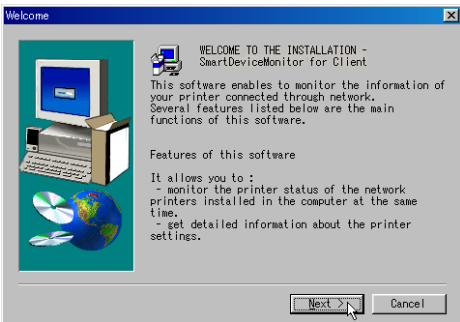

Software License Agreement appears.

- 8** Make sure you read it carefully, and then click [Yes].

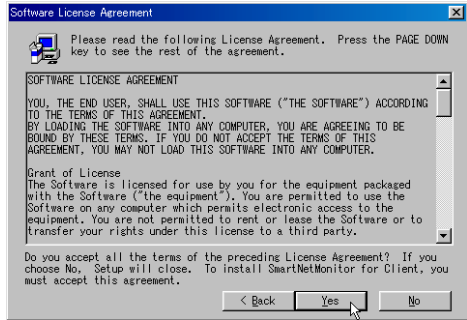

- 9** Follow the steps displayed on the screen to complete the installation of SmartDeviceMonitor for Client.

SmartDeviceMonitor for Admin

- 1** Before beginning installation, exit all other applications.
- 2** Insert the CD-ROM that contains NIC FAX Driver and Utilities into the CD drive on your computer. The Select Language dialog box appears.
- 3** Select the language you want, and then click [OK].

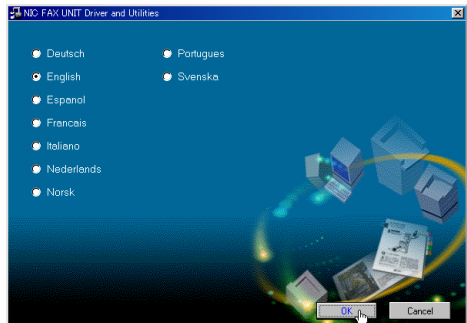

The install program starts.

4 Click [SmartDeviceMonitor for Client / Admin].

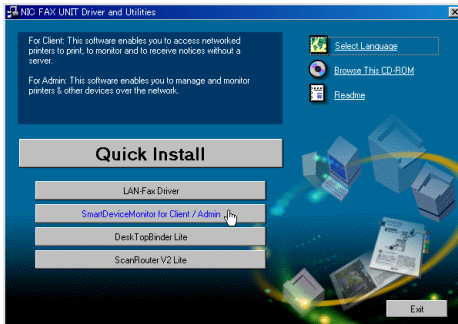

[Add Printer and Utility Wizard] starts, and Software License Agreement appears.

5 Make sure you read it carefully, click [I accept the agreement.], and then click [Next].

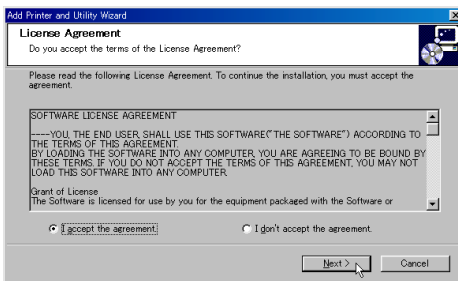

6 Select the [SmartDeviceMonitor for Admin] check box, and then click [Next].

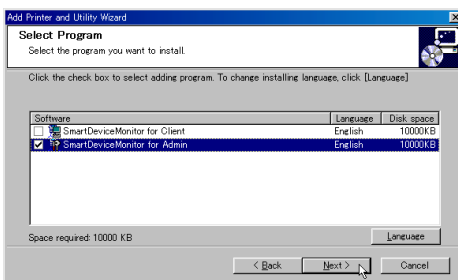

The [Welcome] dialog box appears.

7 Click [Next].

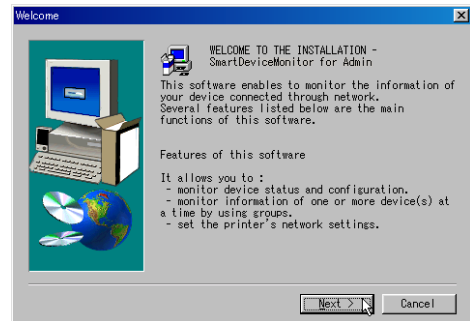

Software License Agreement appears.

8 Make sure you read it carefully, and then click [Yes].

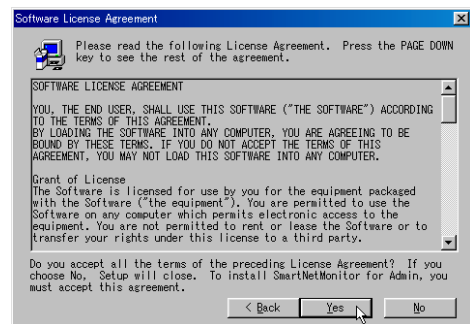

9 Follow the steps displayed on the screen to complete installation of SmartDeviceMonitor for Admin.

DeskTopBinder Lite

1 Before beginning installation, exit all other applications.

2 Insert the CD-ROM that contains the NIC FAX Driver and Utilities into the CD drive on your computer.

The Select Language display appears.

- 3 Select the language you want, and then click [OK].

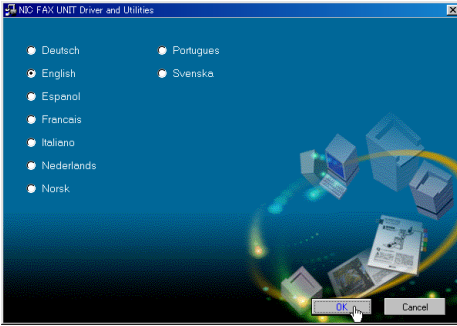

The install program starts.

- 4 Click [DeskTopBinder Lite].

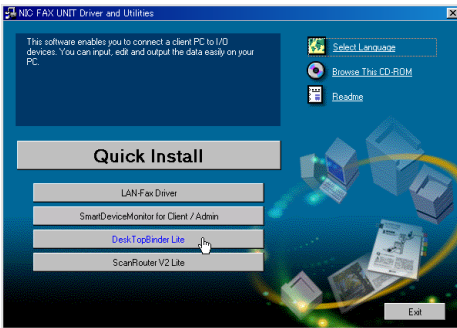

The DeskTopBinder Lite Setup display appears.

- 5 Click [Setup Guide] and follow the steps described in the PDF manual to complete installation.

Note

- To view the PDF manual, you need Adobe Acrobat Reader installed on your computer. If you need to install it, click [Acrobat Reader].

ScanRouter V2 Lite

- 1 Before beginning installation, exit all other applications.

- 2 Insert the CD-ROM that contains NIC FAX Driver and Utilities into the CD drive on the server computer.

The Select Language display appears.

- 3 Select the language you want, and then click [OK].

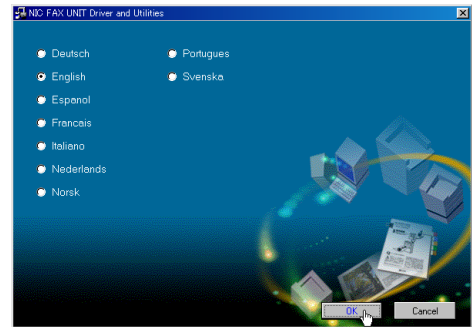

The install program starts.

- 4 Click [ScanRouter V2 Lite].

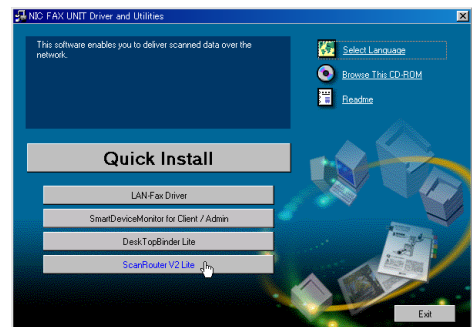

The ScanRouter V2 Lite Setup display appears.

- 5 Click [Setup Guide] and follow the steps described in the PDF manual to complete installation.

Note

- To view the PDF manual, you need Acrobat Reader installed on your computer. If you need to install it, click [Acrobat Reader].

Software Included on the CD-ROM

List of Files

The software for LAN-Fax features or Network Delivery Scanner function is stored in the following directories on the CD-ROM.

CD-ROM	SETUP.EXE			Software installer
	DRIVERS	LAN-Fax	WIN9X_ME	LAN-Fax Driver, Address Book, LAN-Fax Cover Sheet Editor (for Windows 95/98/Me)
			NT4	LAN-Fax Driver, Address Book, LAN-Fax Cover Sheet Editor (for Windows NT4.0)
			WIN2000	LAN-Fax Driver, Address Book, LAN-Fax Cover Sheet Editor (for Windows 2000/XP)
	HELP	WSMHLP	de	Help file for using a Web browser (Deutsch)
			en	Help file for using a Web browser (English)
			es	Help file for using a Web browser (Español)
			fr	Help file for using a Web browser (Français)
			it	Help file for using a Web browser (Italiano)
			nl	Help file for using a Web browser (Nederlands)
			no	Help file for using a Web browser (Norsk)
			sv	Help file for using a Web browser (Svenska)
	NET-WORK	DEVMON	ADMIN	SmartDeviceMonitor for Admin
			CLIENT	SmartDeviceMonitor for Client
	UTILITY	ROUTERV2		ScanRouter V2 Lite
DESK		DeskTopBinder Lite		

LAN-Fax Driver

LAN-Fax Driver enables you to send and print documents created using a computer.

Note

- See LAN-Fax Help for detailed instructions.

Reference

p.107 "Using LAN-Fax Functions"

File Location

LAN-Fax Driver is stored in the following directories:

- LAN-Fax Driver for Windows 95/98/Me
 \DRIVERS\LAN-FAX\WIN9X_ME
- LAN-Fax Driver for Windows NT 4.0
 \DRIVERS\LAN-FAX\NT4
- LAN-Fax Driver for Windows 2000/XP, Windows Server 2003
 \DRIVERS\LAN-FAX\WIN2000

System Requirements

- Computer
 IBM PC/AT or compatible running Windows 95, Windows 98, Windows Me, Windows NT4.0, Windows 2000, Windows XP, Windows Server 2003

Limitation

- LAN-Fax Driver does not work with Windows NT on RISC processors (MIPS R series, Alpha AXP or PowerPC).
- Operating System
 Microsoft Windows 95/98/Me
 Microsoft Windows NT4.0
 Microsoft Windows 2000/XP
 Microsoft Windows Server 2003
- Display
 VGA 640×480 or higher resolution

Address Book

Address Book allows you to program destinations for fax transmissions using LAN-Fax functions.

Note

- Address Book is saved as a CSV file. You can register 2000 addresses in a CSV file, and specify destinations using multiple CSV files.
- See Address Book Help for detailed instructions.

Reference

p.110 "Address Book"

❖ Operating System

- Microsoft Windows 95/98/Me
- Microsoft Windows NT4.0
- Microsoft Windows 2000/XP
- Microsoft Windows Server 2003

LAN-Fax Cover Sheet Editor

LAN-Fax Cover Sheet Editor helps you edit LAN-Fax cover sheets.

❖ Operating System

- Microsoft Windows 95/98/Me
- Microsoft Windows NT4.0
- Microsoft Windows 2000/XP
- Microsoft Windows Server 2003

SmartDeviceMonitor for Client

SmartDeviceMonitor for Client allows you to use NIC FAX as a network printer.

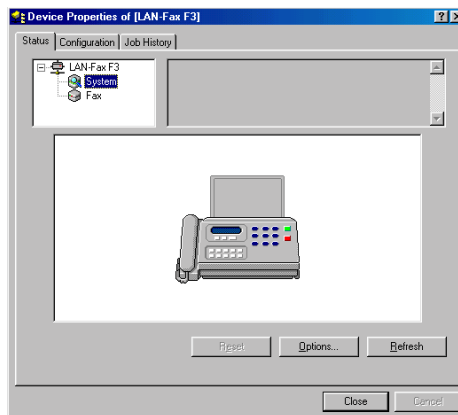

Note

- ☐ See SmartDeviceMonitor for Client Help for the detailed instructions.

❖ File Location

SmartDeviceMonitor for Client is stored in the following directory on the CD-ROM:

NETWORK\DEVMON\CLIENT

❖ Operating System

- Microsoft Windows 95/98/Me
- Microsoft Windows NT4.0
- Microsoft Windows 2000/XP

SmartDeviceMonitor for Admin

SmartDeviceMonitor for Admin is a network utility for administrator with it, you can confirm NIC FAX settings and conditions from a computer.

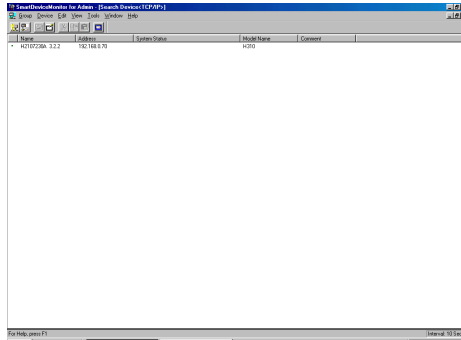

 **Note**

❑ See SmartDeviceMonitor for Admin Help for the detailed instructions.

❖ **File Location**

SmartDeviceMonitor for Admin is stored in the following directory on the CD-ROM:
NETWORK\DEVMON\ADMIN

❖ **Operating System**

- Microsoft Windows 95/98/Me
- Microsoft Windows NT4.0
- Microsoft Windows 2000/XP

DeskTopBinder Lite

DeskTopBinder Lite enables you to handle various data including scanned images, documents or files created with various software, or image files you already have. This software is installed on client computers. With it, you can use NIC FAX as a network delivery scanner, or view the documents in the Fax In-Tray saved using ScanRouter V2 Lite/Professional.

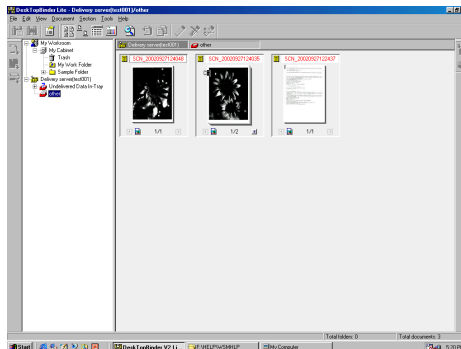

 **Note**

❑ See DeskTopBinder Lite Help for the detailed instructions.

❖ File Location

DeskTopBinder Lite is stored in the following directory on the CD-ROM:
UTILITY\DESK

❖ System Requirements

- Computer
IBM PC/AT or compatible running Windows 98 SE, Windows Me, Windows 2000, Windows XP, Windows Server 2003

📍 Limitation

- DeskTopBinder Lite does not work with Windows 95, Windows 98 and Windows NT.

- Operating System
Microsoft Windows 98 SE
Microsoft Windows Millennium Edition (Windows Me)
Microsoft Windows 2000 Professional (Service Pack 1 or later)
Microsoft Windows 2000 Server (Service Pack 1 or later)
Microsoft Windows XP Professional
Microsoft Windows XP Home Edition
Microsoft Windows Server 2003 Standard Edition
Microsoft Windows Server 2003 Enterprise Edition

❖ Software Installed with DeskTopBinder Lite

- Auto Document Link
Monitors the delivery server regularly, picks up newly arrived documents in the Fax In-Tray, and sends notification to users when new documents are delivered to the server.
Also, automatically registers the saved file under the specified directory to DeskTopBinder Lite.

ScanRouter V2 Lite

With ScanRouter V2 Lite installed, the delivery server enables you to sort scanned documents and images, save them in specified inboxes, and send them to designated client folders.

📝 Note

- See ScanRouter V2 Lite Help for detailed instructions.

❖ File Location

ScanRouter V2 Lite is stored in the following directory on the CD-ROM:
UTILITY\ROUTERV2

❖ System Requirements

- Computer
IBM PC/AT or compatible running Windows 95, Windows 98, Windows Me, Windows NT4.0, Windows 2000, Windows XP
- Operating System
Microsoft Windows 95 operating system OSR2 or later
Microsoft Windows 98/98SE operating system

- Microsoft Windows Millennium Edition (Windows Me)
- Microsoft Windows NT Workstation operating system version 4.0 (Service Pack 5 or later)
- Microsoft Windows NT Server network operating system version 4.0 (Service Pack 5 or later)
- Microsoft Windows 2000 Professional (Service Pack 1 or later)
- Microsoft Windows 2000 Server (Service Pack 1 or later)
- Microsoft Windows XP Professional
- Microsoft Windows XP Home Edition

❖ **Software Installed with ScanRouter V2 Lite**

- Administration Utility
This application helps you run the delivery network system using ScanRouter V2 Lite.
With this utility, the destination(s) of scanned documents and sender(s) information can be programmed into the delivery server. It also performs maintenance operations such as monitoring free disk space on the delivery server, and recording error logs.

 **Note**

- Administration Utility can be installed on client computers as well as the delivery server. To install it, click **[Administration Utility]** on the ScanRouter V2 Lite display of the installer.

Online Help

You can refer to this when you confirm or edit NIC FAX settings using a Web browser.

 **Note**

- To use online Help, see p.157 “Using Online Help”.
- The online Help file is common for Windows 95/98/Me, Windows NT4.0, and Windows 2000/XP.

❖ **File Location**

The online Help files are stored in the following directories on the CD-ROM:

Deutsch	\HELP\WSMHLP\de
English	\HELP\WSMHLP\en
Español	\HELP\WSMHLP\es
Français	\HELP\WSMHLP\fr
Italiano	\HELP\WSMHLP\it
Nederlands	\HELP\WSMHLP\nl
Norsk	\HELP\WSMHLP\no
Português	\HELP\WSMHLP\pt
Svenska	\HELP\WSMHLP\sv

3. Using Scan to E-mail Functions

There are two types of scanner related functions Scan to E-mail and Network Delivery Scanner. This section describes the Scan to E-mail function. If you want to deliver the scanned data to destinations registered to a networked ScanRouter V2 Lite server or ScanRouter V2 Professional server, see p.117 "Using Network Delivery Scanner Functions".

Scanning a Color Original

You can scan and transmit originals in color using NIC FAX. The scanned image is attached to an e-mail as a PDF or JPEG file.

Preparation

You need to make Network settings beforehand. See p.28 "NIC FAX Initial Settings".

Limitation

- You cannot use this feature with Memory Transmission. Use it with Immediate Transmission.
- If the fax machines at both ends are NIC FAX, the file exchange by using the Color Scanning function is not possible. If you attempt such transmissions, documents will not be received and a Mail Information / Error Mail Notification / Error Report will be printed on the transmitting or receiving end NIC FAX.
- You cannot specify an Internet fax machine as destination.
- You cannot specify an e-mail address for the Scan to E-mail function and a destination on the Network Delivery Scanner both at the same time.

Note

- You can store the **【Color Scan】** key into a Keystroke Program. If you regularly send color documents to particular destinations in the same size and format (PDF or JPEG), you can store the program and send quickly by just pressing the Quick Dial key you store the program in. For details about storing a program, see Chapter 6 "Programs", *Advance Features*.

When sending documents, you can set e-mail options using the **【Trans. Option】** key.

If the Mail Options function is already assigned to a user function key (**【F1】** to **【F10】**), you can set the same options using that key.

You can set the following options:

Subject and Message

You can enter a subject and message for the document you want to send. You can also enter either subject or message only.

Note

- To enter a message, you need to assign the E-mail Message function to a user function key beforehand. See p.25 "Assigning User Function Keys". The E-mail Message function is pre-assigned to the **【F4】** key.

- ❑ If you send e-mail without setting a subject/message in "Subject/Message" under "Mail Options" when a subject/message is already registered as No.1 in "Template: Subject", the registered subject/message is automatically used. For more details about registering subjects/messages, see p.149 "Registering Template Subjects and Messages". If you send e-mail without setting a subject/message in "Subject/Message" under "Mail Options" when a subject/message is not registered, the subject is automatically inserted. For more details about how a subject is automatically inserted, see p.79 "About the E-mail Subject".
 - ❑ You cannot send only a subject/message as an e-mail without an original.
- ❖ **Heading**
You can add "Urgent" in front of the document subject.
- ❖ **Confirmation of Reception**
You can confirm sent documents were properly received using e-mail or the Journal.
-  **Note**
- ❑ If you specify multiple destinations, the Confirmation of Reception becomes invalid.
 - ❑ You cannot send color originals to destinations already registered for Internet FAX or IP-FAX in Quick Dial or Speed Dial keys. Specify destinations for the scanner when you send originals in color. See p.133 "Registering Addresses for Scanner".
 - ❑ The Color Scanning feature is not available with Backup Transmission.
- ❑ You need to select a format of transmitted files with user parameters or the user function key. If you frequently switch the format, it is recommended that you assign the JPEG function to a user function key so that you can switch the format easily. The JPEG function is pre-assigned to the **[F9]** key. See p.26 "JPEG" and p.166 "User Parameters" (switch 17, bit 5).
 - ❑ You can adjust the quality of images transmitted using the Color Scanning feature with user parameters. If you make a setting that reduces the difference between values for Brightness and Color Difference (for example, "Brightness: 1, Color Difference: 1, Color Difference: 1"), the quality of images increases, but the data size also increases. You do not need to make changes to default settings. For more information, see p.166 "User Parameters" (switch 33: bit 1,0). However, this setting is not valid when PDF is selected as the file format for Color Scanning with user parameters (switch 17, bit 5).
 - ❑ You can adjust the color balance. See p.66 "Scanner RGB".
 - ❑ Adobe Acrobat Reader is necessary for viewing PDF files.
 - ❑ The following functions are invalid even if you specify them:
 - Fax Header Print
 - Label Insertion
 - Maximum Mail Size
 - Viewer URL Information

- 1 Make sure the Memory Trans. indicator is not lit.

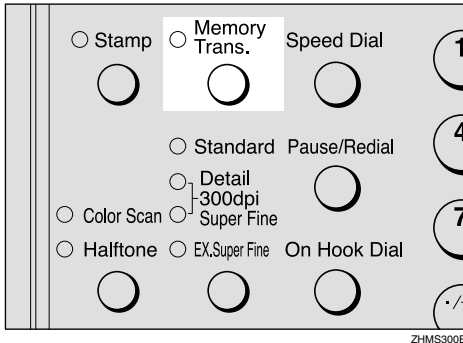

Note

- If the Memory Trans. indicator is lit, press the **[Memory Trans.]** key.

- 2 Press the **[Color Scan]** key.

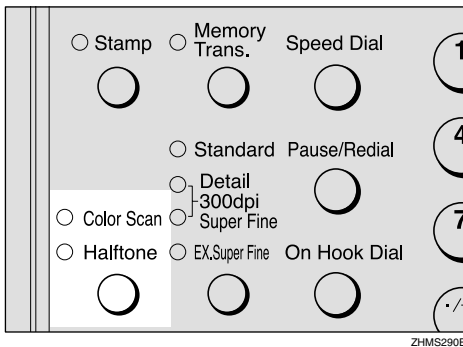

Make sure the Color Scan indicator is lit.

- 3 Press the **[Left Arrow]** or **[Right Arrow]** key to select the original size, and then press the **[OK]** key.

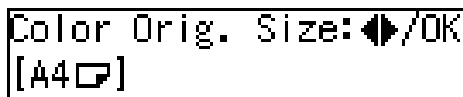

- 4 Make any settings for "Mail Options", if necessary.

Note

- Proceed to step 6 if you do not want to make any Mail Options settings.

Using **[Trans. Option]** Key

- 1 Press the **[Trans. Option]** key.

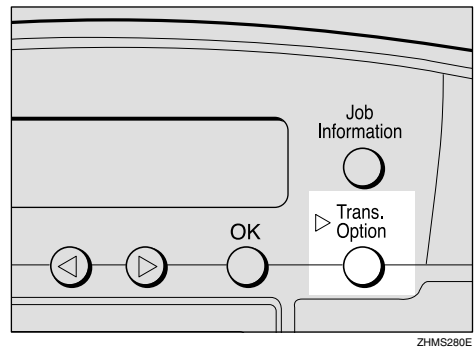

- 2 Press the **[Left Arrow]** or **[Right Arrow]** key to display "10. Mail Options".

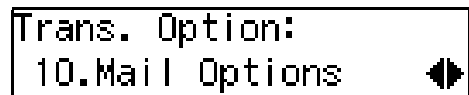

- 3 Press the **[OK]** key.

Using the User Function Key

- 1 Press the user function key (**[F1]** to **[F10]**) assigned to the Mail Options function.

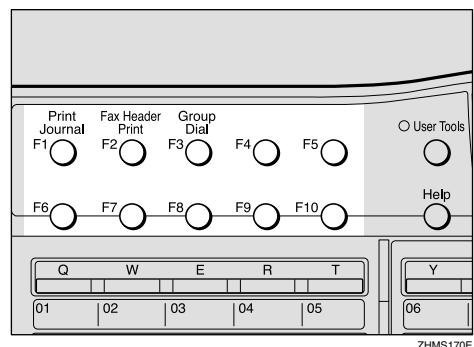

5 Press **⏪** or **⏩** key to display the item you want to set, and then press the **[OK]** key.



Subject/Message

1 Enter the subject.



Note

- If you do not want to enter a subject, proceed to step **2**.
- If a subject/message is registered as No.1, it automatically appears on the display above. If you want to enter another subject/message, press the **[Clear/Stop]** key to delete it, and then enter the subject/message.
- To enter a subject/message registered in "Template: Subject", press the **[★]** key, press the **⏪** or **⏩** key to display the desired subject/message, and then press the **[OK]** key.
- If you enter only a subject, you can enter up to 150 characters.
- If you enter only a message or both subject and message, you can enter up to 148 characters for message, since space for two characters is used by pressing the E-mail Message function.

Reference

Chapter 3 "Entering Characters", *Basic Features*
 p.149 "Registering Template Subjects and Messages"

2 If you want to enter a message, press the user function key (**[F1]** to **[F10]**) assigned to the E-mail Message function.

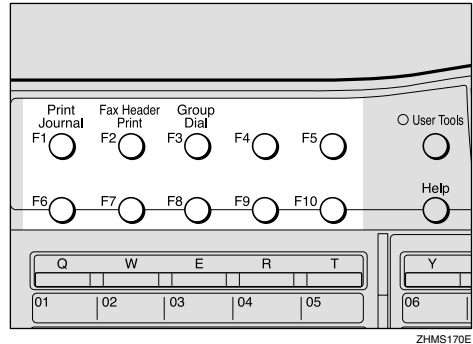

Note

- If you do not want to enter a message, proceed to step **4**.

3 Enter a message.



4 Press the **[OK]** key.

Heading

1 Press the **⏪** or **⏩** key to select "No" or "Urgent".

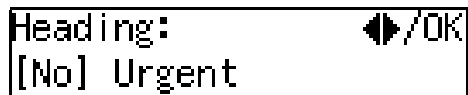

2 Press the **[OK]** key.

Confirmation of Reception

1 Press the **⏪** or **⏩** key to select "Yes" or "No".

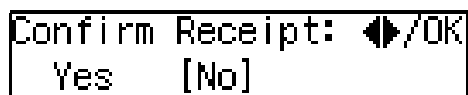

Reference

p.80 "Confirming Reception"

② Press the **[OK]** key.

⑥ Set the original.

⑦ Press the **[Resolution]** key to select data resolution.

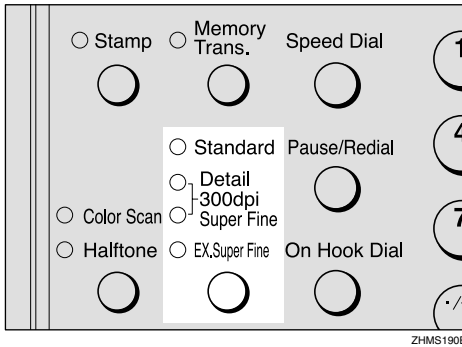

Note

- ❑ In order to set resolution to Extra Super Fine, you need to make necessary settings with user parameters. For information about making this setting, see p.166 "User Parameters" (switch 20, bit 2).

⑧ Specify the destination.

Specifying by the E-mail Address

① Press the user function key (**[F1]** to **[F10]**) assigned to the Scanner (Scan to E-mail) function.

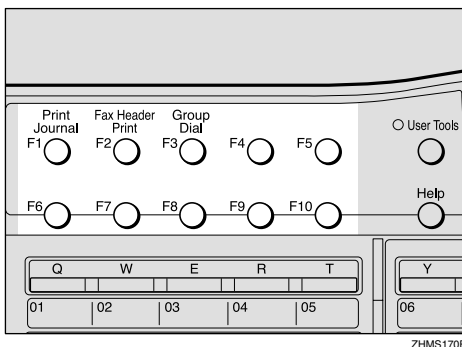

Note

- ❑ The Scanner (Scan to E-mail) function is pre-assigned to the **[F10]** key.

- ❑ You do not need to press the user function key in the following cases:

- When the e-mail address is stored in either Quick Dial key, Speed Dial, or Group Dial.
- When specifying the address using the Redial function.

Reference

Chapter 2 "Dialing", *Basic Features*

Chapter 3 "Redial", *Advanced Features*

② Enter the e-mail address of the destination.

```
Scanner: [abc] Press OK
nicf2@def.company.com
```

Note

- ❑ You can enter up to 127 characters for an e-mail address.
- ❑ You can enter "." and "@" using a Quick Dial key. Press the **[Symbols]** key to enter symbols. You can shift between upper and lower case by pressing the **[ABC/abc]** key.
- ❑ To enter texts registered in "Template: Address", press the **[★]** key, press the **[⏪]** or **[⏩]** key to display the desired text, and then press the **[OK]** key. See p.147 "Registering Template Addresses".
- ❑ If you incorrectly enter characters, press the **[Clear/Stop]** key, and then enter the correct characters.

③ Press the **[OK]** key.

Specifying the Destination

- 1 Specify the destination using a Quick Dial key or Speed Dial.



Note

- You can specify the destination using methods other than Quick Dial or Speed Dial. See p.120 "Specifying Destinations Without Using Quick Dial Keys or Speed Dials".

- 9 To add one or more destinations, press the [OK] key, and then repeat step 8.

Note

- If you do not want to add any other destinations, proceed to step 10.

- 10 Press the [Start] key.

The transmission begins.

Note

- To cancel transmission of a Scan to E-mail, follow the same procedure as for canceling an Internet fax. See p.96 "Canceling Transmission of an Internet Fax".

Scanner RGB

You can adjust the color balance for Color Scanning by using the Scanner RGB feature.

- 1 Press the [User Tools] key.

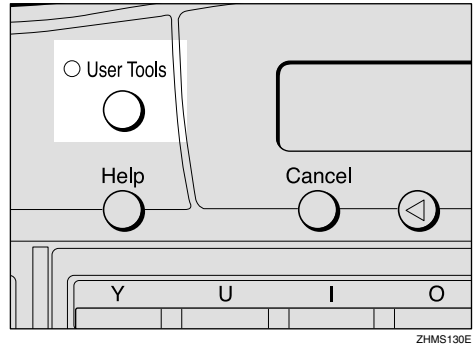

Note

- Start this procedure when the standby display is shown on the display. If the standby display is not shown, make it reappear. See Chapter 1 "Standby Display", *Basic Features*.

- 2 Press the [Left] or [Right] key to display "2. Fax Features".



- 3 Press the [OK] key.

The Fax Features main menu appears.

- 4 Press the [Left] or [Right] key to display "3. Setup".

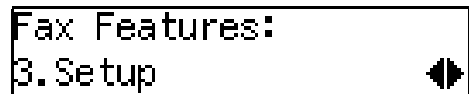

- 5 Press the [OK] key.

The Setup main menu appears.

- 6** Press the ◀ or ▶ key to display "7. Scanner RGB".



Setup:
7. Scanner RGB ▶

- 7** Press the [OK] key.
The Scanner RGB display appears.

- 8** Press the ◀ or ▶ key to display the color you want to adjust.



Scanner RGB:
1. Red (R) ▶

- 9** Press the [OK] key.
10 Press the ◀ or ▶ key to make adjustments, and then press the [OK] key.



Red (R): ▶/OK
- ████ +

The display in step **8** appears.

- 11** Repeat steps **8** to **10** as many times as necessary.
12 Press the [User Tools] key.
The standby display reappears.

Scanning a Monochrome Original

You can scan monochrome originals and transmit them as image files with e-mail. The originals are converted into PDF or TIFF-F image files.

Preparation

You need to make Network settings beforehand. See p.28 "NIC FAX Initial Settings".

The content of originals is transmitted as an attachment to the e-mail in PDF or TIFF-F files. You can specify a format with user parameters. See p.166 "User Parameters" (switch 17, bit 5).

Limitation

- If you specify the format of an attached image file to PDF, Viewer URL Information function is invalid even if you set it with "Mail Options".

When sending documents, you can set e-mail options using the **[Trans. Option]** key.

If the Mail Options function is already assigned to a user function key (**[F1]** to **[F10]**), you can set the same options using that key.

You can set the following options:

❖ Subject and Message

You can enter a subject and message for the document you want to send. You can also enter either subject or message only.

Note

- To enter a message, you need to assign the E-mail Message function to a user function key beforehand. See p.25 "Assigning User Function Keys". The E-mail Message function is pre-assigned to the **[F4]** key.

- If you send e-mail without setting a subject/message in "Subject/Message" under "Mail Options" when a subject/message is already registered as No.1 in "Template: Subject", the registered subject/message is automatically used. For more details about registering subjects/messages, see p.149 "Registering Template Subjects and Messages". If you send e-mail without setting a subject/message in "Subject/Message" under "Mail Options" when a subject/message is not registered, the subject is automatically inserted. For more details about how a subject is automatically inserted, see p.79 "About the E-mail Subject".
- You cannot send a subject/message only as e-mail without an original.

❖ Heading

You can add "Urgent" in front of the document subject.

❖ Confirmation of Reception

You can confirm sent documents were properly received using e-mail or the Journal.

❖ Viewer URL Information

You can record URL sites for downloading viewer applications on e-mail you are about to send.

Note

- You need Acrobat Reader for viewing PDF files.
- The following functions are invalid even if you specify them:
 - Fax Header Print
 - Label Insertion
- When you transmit e-mail by the Scanner function specifying a user code, and the e-mail address is set as the routing destination of the specified user code, a Communication Result Report is sent after the transmission is completed. This makes it possible to verify the result of a transmission. See p.176 "Communication Result Report".

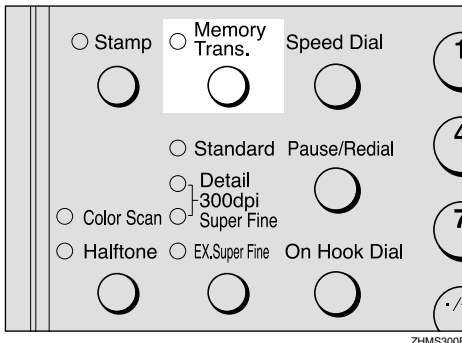
1 Make sure the Memory Trans. indicator is lit.**Note**

- If the **Memory Trans.** indicator is not lit, press the **[Memory Trans.]** key.

2 Make any settings for "Mail Options", if necessary.**Note**

- Proceed to step **4** if you do not want to make any Mail Options settings.

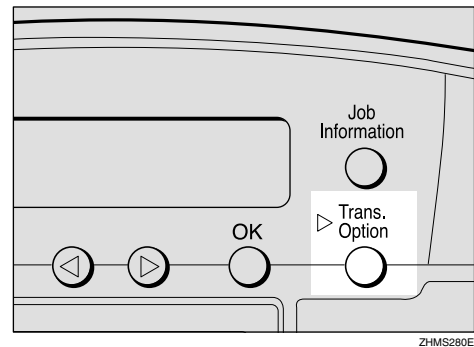
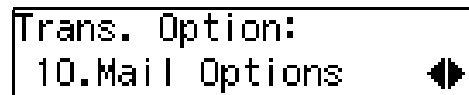
Using **[Trans. Option]** Key**1** Press the **[Trans. Option]** key.**2** Press the **◀** or **▶** key to display "10. Mail Options".**3** Press the **[OK]** key.

Using the User Function Key

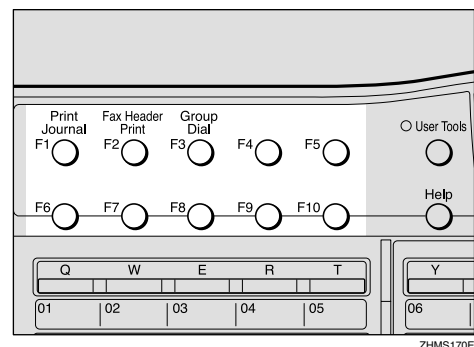
1 Press the user function key (**[F1]** to **[F10]**) assigned to the Mail Options function.

3 Press **⏪** or **⏩** key to display the item you want to set, and then press the **[OK]** key.



Subject/Message

1 Enter the subject.



Note

- If you do not want to enter a subject, proceed to step **2**.
- If a subject/message is registered as No.1, it automatically appears on the display above. If you want to enter another subject/message, press the **[Clear/Stop]** key to delete it, and then enter the subject/message.
- To enter a subject/message registered in "Template: Subject", press the **[★]** key, press the **⏪** or **⏩** key to display the desired subject/message, and then press the **[OK]** key.
- If you enter only a subject, you can enter up to 150 characters.
- If you enter only a message or both subject and message, you can enter up to 148 characters for message, since space for two characters is used by pressing the E-mail Message function.

Reference

Chapter 3 "Entering Characters", *Basic Features*
 p.149 "Registering Template Subjects and Messages"

2 If you want to enter a message, press the user function key (**[F1]** to **[F10]**) assigned to the E-mail Message function.

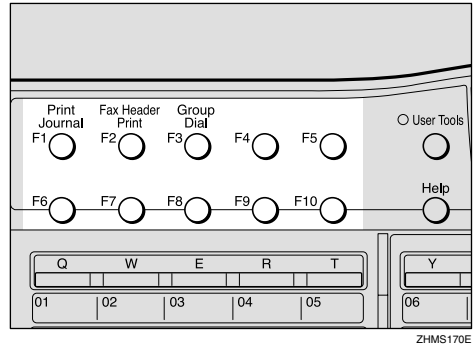

Note

- If you do not want to enter a message, proceed to step **4**.

3 Enter a message.



4 Press the **[OK]** key.

Heading

1 Press the **⏪** or **⏩** key to select "No" or "Urgent".

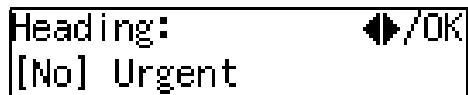

2 Press the **[OK]** key.

Confirmation of Reception

1 Press the **⏪** or **⏩** key to select "Yes" or "No".

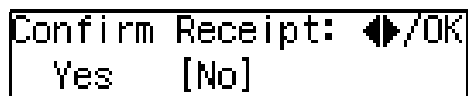

Reference

p.80 "Confirming Reception"

- 2 Press the **[OK]** key.

Viewer URL Information

- 1 Press the **[Left]** or **[Right]** key to select "Yes" or "No".

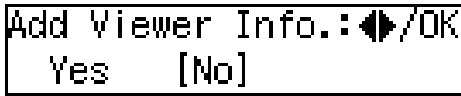

- 2 Press the **[OK]** key.

- 4 Set the original.

- 5 Press the **[Resolution]** key to select data resolution.

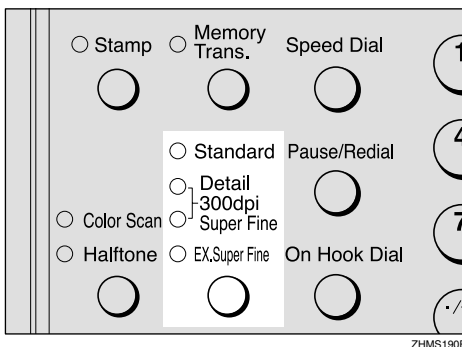

Note

- When you are specifying the Broadcasting function with a fax or an Internet fax message, the resolution of the message is automatically set to 200 × 200 dpi, even if you specify 300dpi.
- In order to set resolution to Extra Super Fine, you need to make necessary settings with user parameters. For information about making this setting, see p.166 "User Parameters" (switch 20, bit 2).

- 6 Press the user function key (**[F1]** to **[F10]**) assigned to the Scanner (Scan to E-mail) function.

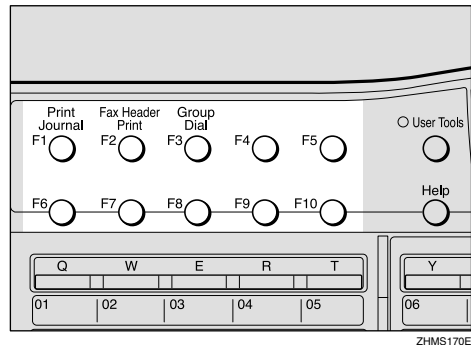

The display for entering the scanner destination appears.

Note

- The Scanner (Scan to E-mail) function is pre-assigned to the **[F10]** key.
- You do not need to press the user function key in the following cases:
 - When the e-mail address is stored in either Quick Dial key, Speed Dial, or Group Dial.
 - When specifying the address using the Redial function.

Reference

Chapter 2 "Dialing", *Basic Features*

Chapter 3 "Redial", *Advanced Features*

- 7 Specify the e-mail address using the Quick Dial key or number keys.



 **Note**

- You can enter up to 127 characters for an e-mail address.
- You can enter the "." and "@" with the Quick Dial keys. Press the **[Symbols]** key when you want to enter other symbols. Use the **[ABC/abc]** key to shift between uppercase and lowercase characters.
- To enter texts registered in "Template: Address", press the **[★]** key, press the **[◀]** or **[▶]** key to display the desired text, and then press the **[OK]** key. See p.147 "Registering Template Addresses".

8 Press the **[OK]** key.

The destination is set.



9 To add one or more addresses, press the **[OK]** key, and then repeat steps **6** to **8**.

 **Note**

- If you do not want to add any other addresses, proceed to step **10**.
- You can also specify destinations of faxes using public telephone line. In this case, omit step **6**.

10 Press the **[Start]** key.

This starts reading the document into memory. The e-mail send operation starts after the read operation is complete. The Communicating indicator is lit when a send operation is in progress.

 **Note**

- With a large volume of documents, it may take some time before transmission starts. This is due to the time the machine requires to convert data in memory.
- To cancel transmission of a Scan to E-mail, follow the same procedure as for canceling an Internet fax. See p.96 "Canceling Transmission of an Internet Fax".

4. Using Internet Fax Functions

E-mail Server Settings (by Network Administrator)

The information in this section is for your network administrator.

Mail Server Settings

NIC FAX uses an Internet e-mail system to send Internet faxes. Since it automatically connects to the e-mail server to get e-mail, a NIC FAX account and password must be set up on the e-mail server. In order to use SMTP reception, an entry indicating that NIC FAX is capable of SMTP reception must be made in the DNS server's MX record. See the documentation for the e-mail server for details on the procedure required for setting up accounts and passwords.

Be sure to provide the NIC FAX's IP address or host name to NIC FAX users who need to input this information when establishing a connection through a Web browser.

E-mail Servers That Have Been Confirmed to Work

❖ **Sendmail/QUALCOM Pop server**

Program: SMTP sendmail Ver.8 or higher POP QUALCOM Pop server
OS: Solaris 1 Ver.2.1.4-R3

❖ **Post.Office**

Version: Ver.3.1 Release PO203a
Agency: Software.com

❖ **Seattle Lab Mail Server**

Version: Ver.4.1
Agency : Seattle Lab Inc.

❖ **Netscape Messaging Server**

Version: Ver.3.0
Agency: Netscape Communications

❖ **IMail Server for Windows NT**

Version: Ver.4.0
Agency: Ipswitch, Inc.

! **Limitation**

❑ Supported operations and services differ according to the e-mail server used.

Transmitting Internet Fax

Preparation

You need to make Network settings beforehand. See p.28 "NIC FAX Initial Settings".

This section describes how to scan a document into NIC FAX memory and send it as e-mail. You can enter the e-mail address directly, or use a Quick Dial key, Speed Dial or Group with an address already stored in it. You can also use the **[Redial]** key to recall the previous address sent to.

When sending documents, you can set e-mail options using the **[Trans. Option]** key.

If the Mail Options function is already assigned to a user function key (**[F1]** to **[F10]**), you can set the same options using that key.

You can set the following options:

❖ Subject and Message

You can enter a subject and message for the document you want to send. You can also enter either subject or message only.

Note

- To enter a message, you need to assign the E-mail Message function to a user function key beforehand. See p.25 "Assigning User Function Keys". The E-mail Message function is pre-assigned to the **[F4]** key.

- If you send e-mail without setting a subject/message in "Subject/Message" under "Mail Options", the subject is automatically inserted. For more details about how a subject is automatically inserted, see p.79 "About the E-mail Subject". However, if a subject/message is already registered as No.1 in "Template: Subject", the registered subject/message is automatically used. For more details about registering subjects/messages, see p.149 "Registering Template Subjects and Messages".

- You cannot send a subject/message only as e-mail without an original.

❖ Heading

You can add "Urgent" in front of the document subject.

❖ Confirmation of Reception

You can confirm sent documents were properly received using e-mail or Journal.

❖ Viewer URL Information

You can record URL sites for downloading viewer applications on e-mail you are about to send.

Important

- You may not be able to send large files as e-mail, depending on e-mail environment conditions.
- The level of security for Internet communications is low. Use of the telephone network is recommended for confidential communications.

Note

- ❑ Because NIC FAX sends documents as e-mail messages with an attached TIFF-F image, viewer applications are required in order to view documents when they are received on a computer. You can inform the receiver of sites for downloading viewer applications using the Viewer URL Information mail option.
- ❑ When you send viewer URL information, depending on the receiver's fax machine, Journal may show a page count that is one or two pages greater than the number of pages actually sent.
- ❑ See p.183 "Received Images" for how e-mail is actually received by the computer when it is sent with mail options selected.
- ❑ With the Scanner function, you can transmit color documents from this machine with optional color unit. However, the Internet Faxing function does not support color transmission. For information about Color Scanning, see p.61 "Scanning a Color Original".
- ❑ When you transmit an Internet Fax specifying a user code, and the e-mail address is set as the routing destination of the specified user code, a Communication Result Report is sent after the transmission is completed. This makes it possible to verify the result of a transmission. See p.176 "Communication Result Report".

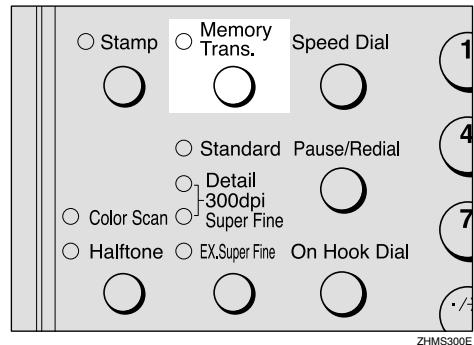
1 Make sure that the **Memory Trans. indicator** is lit.**Limitation**

- ❑ When using NIC FAX to send e-mail over the Internet, documents are stored in memory, and then sent using Memory Transmission. Internet faxing does not allow immediate transmission.

Note

- ❑ If the **Memory Trans.** indicator is not lit, press the **[Memory Trans.]** key to change back to Memory Transmission.

2 Make any settings for "Mail Options", if necessary.**Note**

- ❑ Proceed to step **4** if you do not want to make any Mail Options settings.

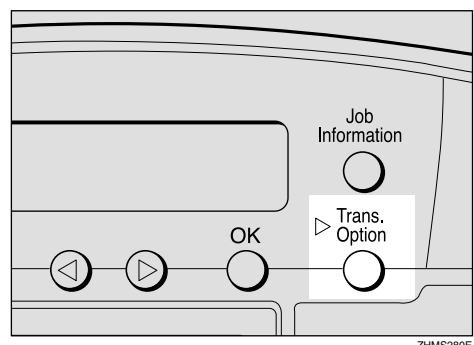
Using **[Trans. Option]** Key**1** Press the **[Trans. Option]** key.

- 2 Press the ⏪ or ⏩ key to display "10. Mail Options".

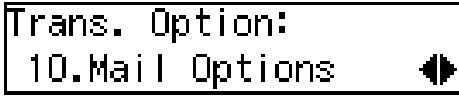

- 3 Press the [OK] key.

Using the User Function Key

- 1 Press the user function key ((F1) to (F10)) assigned to the Mail Options function.

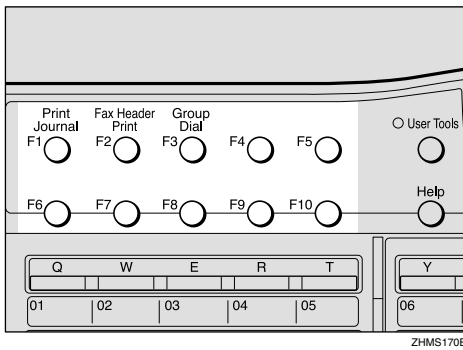

4

- 3 Press the ⏪ or ⏩ key to display the item you want to set, and then press the [OK] key.



Subject/Message

- 1 Enter the subject.



Note

- If you do not want to enter a subject, proceed to step 2.

- If a subject/message is registered as No.1, it automatically appears on the display above. If you want to enter another subject/message, press the [Clear/Stop] key to delete it, and then enter the subject/message.
- To enter a subject/message registered in "Template: Subject", press the [★] key, press the ⏪ or ⏩ key to display the desired subject/message, and then press the [OK] key.
- If you enter only a subject, you can enter up to 150 characters.
- If you enter only message or both subject and message, you can enter up to 148 characters since space for two characters is used by pressing a user function key assigned to the E-mail Message function.

Reference

Chapter 3 "Entering Characters", *Basic Features*

p.149 "Registering Template Subjects and Messages"

- 2 If you want to enter a message, press the user function key ((F1) to (F10)) assigned to the E-mail Message function.

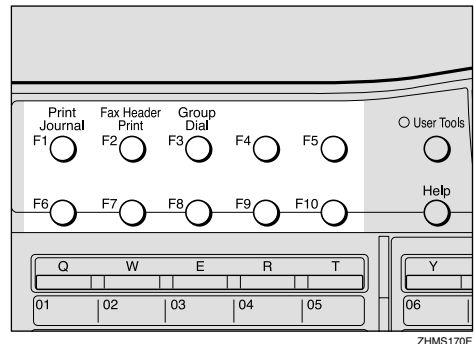

Note

- ❑ If you do not want to enter a message, proceed to step 4.

3 Enter the message.

```
Subject: [ABC]E-Msg./OK
EPORT [ ] PLEASE CONFIRM [ ]
```

4 Press the **[OK]** key.

Heading

- 1 Press the **[◀]** or **[▶]** key to select "No" or "Urgent".

```
Heading: [ ] /OK
[No] Urgent
```

2 Press the **[OK]** key.

Confirmation of Reception

- 1 Press the **[◀]** or **[▶]** key to select "Yes" or "No".

```
Confirm Receipt: [ ] /OK
Yes [No]
```

Reference

p.80 "Confirming Reception"

2 Press the **[OK]** key.

Viewer URL Information

- 1 Press **[◀]** or **[▶]** key to select "Yes" or "No".

```
Add Viewer Info.: [ ] /OK
Yes [No]
```

2 Press the **[OK]** key.

- 4 Set the original and adjust any scan settings as necessary.

Note

- ❑ Original images are sent at Detail resolution even if 300dpi, Super Fine, or Extra Super Fine is selected.

- 5 Press the user function key (**[F1]** to **[F10]**) assigned to the Internet FAX function.

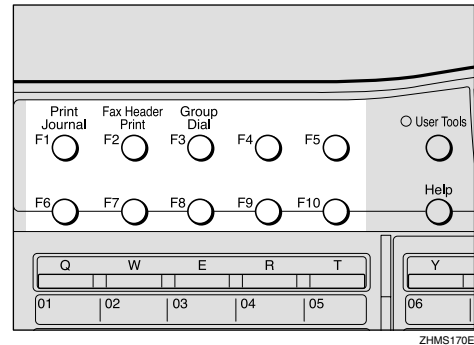

The display for entering an address appears.

Note

- ❑ The Internet FAX function is pre-assigned to the **[F5]** key.
- ❑ You do not need to press the user function key in the following cases:
 - When the e-mail address is stored in a Quick Dial key, Speed Dial, or Group Dial.
 - When specifying the address using the Redial function.

ReferenceChapter 2 "Dialing", *Basic Features*Chapter 3 "Redial", *Advanced Features*

If the Network Transmission Auto Check Function Is Turned Off

If the Network Transmission Auto Check function is set to "Off" with user parameters, select E-mail Transmission in the display that appears. For information about changing this setting, see p.166 "User Parameters" (switch 32, bit 1).

- ❶ Confirm "1. Mail Address" appears, and then press the **[OK]** key.



- ❷ Specify the e-mail address using the Quick Dial key or number keys.

When the Network Transmission Auto Check function is set to On:



When the Network Transmission Auto Check function is set to Off:



Note

- ❑ You can enter up to 127 characters for an e-mail address.
- ❑ You can enter the "." and "@" with the Quick Dial keys. Press the **[Symbols]** key when you want to enter other symbols. Use the **[ABC/abc]** key to shift between uppercase and lowercase characters.

- ❑ To enter texts registered in "Template: Address", press the **[★]** key, press the ⏪ or ⏩ key to display the desired text, and then press the **[OK]** key. See p.147 "Registering Template Addresses".

- ❸ Press the **[OK]** key.

The destination is set.

- ❹ To add one or more addresses, press the **[OK]** key, and then repeat steps ❸ to ❷.

Note

- ❑ If you do not want to add more addresses, proceed to step ❹.
- ❑ You can also specify destinations of faxes using a public telephone line. In this case, omit step ❸.

- ❺ Press the **[Start]** key.

This starts reading the document into memory. The e-mail send operation starts after the read operation is complete. The Communicating indicator is lit when a send operation is in progress.

Note

- ❑ With a large volume of document, it may take some time before transmission starts. This is due to the time NIC FAX requires to convert the data in memory.
- ❑ To cancel transmission of an Internet fax, see p.96 "Canceling Transmission of an Internet Fax".

About the E-mail Subject

If no subject is specified for "Subject/Message" in "Mail Options", the following subject is automatically inserted:

❖ When a User Code Is Set

- If the mail address of the Routing Address is registered:
From "mail address of the Routing Address" Fax Message NO.xxxx.
- If the mail address of the Routing Address is not registered:
From "User Code name" Fax Message NO.xxxx.

❖ When a User Code Is Not Set

- If Own Fax Number and Own Name are registered:
From "Own Fax Number" ("Own Name") (Fax Message NO.xxxx)
- If only Own Fax Number is registered:
From "Own Fax Number" (Fax Message NO.xxxx)
- If only Own Name is registered:
From "Own Name" (Fax Message NO.xxxx)
- If neither Own Fax Number nor Own Name are registered:
Fax Message NO.xxxx

Note

- User codes refer to the names assigned to Confidential Boxes.
- "xxxx" is the document number that appears in the Journal.

Reference

Chapter 3 "Own Name/Fax Header/Own Fax Number", *Basic Features*

Chapter 1 "User Code Transmission", *Advanced Features*

When using NIC FAX with Broadcasting and Sequential Broadcasting

Broadcasting is used to send e-mail when multiple addresses are specified for transmission. With broadcasting, the same e-mail can be sent to multiple addresses at once, just as when ordinary e-mail is sent to multiple addresses.

However, if "Yes" is selected for "Confirm Receipt" or "On" is selected for "Label Insertion", sequential broadcasting is used for transmission. With sequential broadcasting, the e-mail is sent to one address at a time.

Note

- When using Quick Dial keys or Speed Dials to specify a destination, documents with Fax Header 1 and Fax Header 2 selected (according to Fax Header settings under Fax Information) are transmitted separately.
- The Auto Document function transmits specified destination and non-specified destination documents separately.

Confirming Reception

When Reception Confirmation is selected, the receiver sends back a reception confirmation message. Once the reception confirmation message has been received, "OK" appears in the Result column of Journal, allowing the originator to verify that the transmission has been received.

Limitation

- The Reception Confirmation feature is only available if the receiver supports MDN (Message Disposition Notification).

Note

- If your fax is not received normally, "E" appears in the Result column.
- Information regarding the last 250 messages is recorded, but only the last 50 communications appear in Journal. If you do not receive a reception confirmation message for one of the last 50 communications from the receiver's machine, you may not be able to confirm that the e-mail has been received by the Journal's Result column.
- If you specify mailing list addresses, do not select "Yes" for "Confirm Receipt". Otherwise, you will receive multiple reception confirmation messages from e-mail recipients, and the Result column will be overwritten each time a new confirmation message is received. However, if you receive a reception confirmation message indicating an error, "E" appears in the Result column and will not be overwritten, even if you subsequently receive a reception confirmation message as "OK" following the error message.

- Reception confirmation results are only shown in Journal. The Result column in all other files, lists, and transmission reports show "- -".
- Reception confirmation messages themselves are not recorded in Journal.
- To enable Reception Confirmation under "Mail Options", select "Yes" for "Confirm Receipt". Set this to "Yes" with user parameters if you use this function frequently. You can have confirmation of receipt, without having to specify "Confirm Receipt" each time. Once you set this to "Yes" with user parameters, this function can be turned off by selecting "No" for "Confirm Receipt" under "Mail Options". See p.166 "User Parameters" (switch 17, bit 4).
- The reception confirmation notification can be printed out. This can be set with user parameters. See p.166 "User Parameters" (switch 18, bit 7).

Transmitting Journal by E-mail

Preparation

To transmit the Journal by e-mail, it is necessary to make settings with user parameters. See p.166 "User Parameters" (switch 18, bit 5).

The Journal is automatically transmitted to an e-mail address of the administrator by 50 communications. A CSV format Journal is attached to the e-mail. See p.40 "Mail to Admin. (Mail to Administrator)" and p.179 "Journal by E-mail".

Important

- ❑ It is recommended that you double-check the e-mail address of an administrator before the Journal is transmitted. If the e-mail address of the administrator is not correct, your important Journal may be lost and sent CSV file is not left on NIC FAX.

Note

- ❑ Even if the administrator address is wrong, you can acquire Journal from Error Mail Notification by setting that the error e-mail is left on the server. To leave the error e-mail on the server, set "Leave message on POP server after receiving them" to "Save only errors" with user parameters beforehand. See p.166 "User Parameters" (switch 16; bit 1, 0).
- ❑ If you specify the destination of Backup Mail Transmission, the Journal is also transmitted to the destination.
- ❑ If the Journal in e-mail format fails to be transmitted, the Communication Failure Report and Journal are printed out.
- ❑ The name of an attached CSV file is "JOURNAL+year, month, hours, minutes". For example, the file name transmitted in 10:40:12 on 15th, April, 2003 is "JOURNAL20030415104012.csv".
- ❑ The subject of Journal by e-mail begins with "Journal".

Transfer Request

You can request transfer specifying Quick Dial, Speed Dial, and Group destinations registered in Transfer Station. Transfer requests allow you to make use of the Internet to reduce costs, particularly with long distance and international communications.

There are two types of transfer request transmissions: transfer request by e-mail and transfer request by fax (standard transfer request transmission).

The following are some terms you must be familiar with in order to perform the following procedure.

❖ Transfer Requester

This is the fax machine performing the transfer request transmission (this machine).

❖ Transfer Station

This is the fax machine that performs the transfer. This machine needs to be capable of performing transfers.

❖ End Receiver

This is the fax machine or computer that receives the e-mail or fax from the Transfer Station.

Limitation

- ❑ Fax machines that are equipped with NIC FAX KIT TYPE 140, TYPE 500, NIC FAX UNIT TYPE410, or TYPE 510 can be specified as the Transfer Station for a transfer request by e-mail.

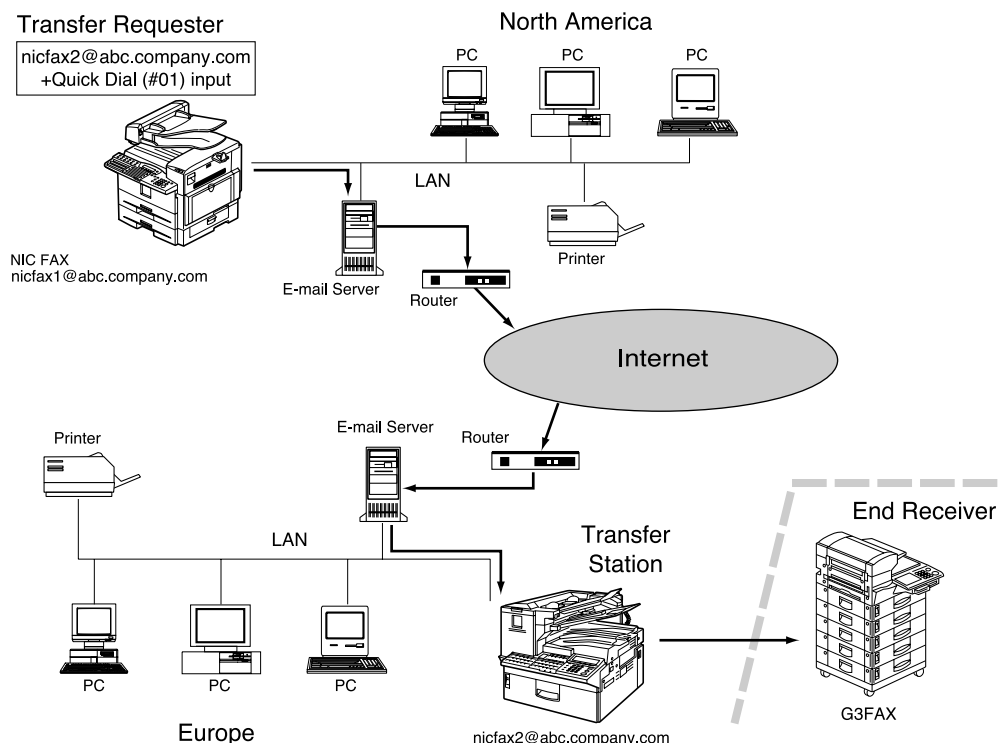

GFTRR00E

Note

- ❑ You can specify one Transfer Station and up to 30 End Receivers in a single Transfer Request.
- ❑ Each group is considered one item when specifying Transfer Stations programmed in Group Dials.
- ❑ If you make a Transfer Request by e-mail, a Transfer Result Report is transmitted to the Transfer Requester by e-mail when Transfer Station completes all transmissions to the End Receivers.
- ❑ You can specify IP-Fax destinations as Transfer Station making a Transfer Request.
- ❑ If you use the Network Boot function, the IP address of the fax machine may be changed after making the Transfer Request by specifying IP-Fax destinations as Transfer Station and the Transfer Result Report cannot be received. If you want to specify an IP-Fax destination as Transfer Station, consult your network administrator in order to keep the same IP address. See p.32 "Network Boot".
- ❑ See Chapter 1 "Transfer Request", *Advanced Features* to send Transfer Requests by fax.

Transfer Request by E-mail

Preparation

In order to use this function, you must make polling ID and Transfer Report settings. The same polling ID must be set for both Transfer Requester and Transfer Stations. See Chapter 7 "ID Codes" and "Transfer Report", *Advanced Features*.

1 Make sure that the Memory Trans. indicator is lit.

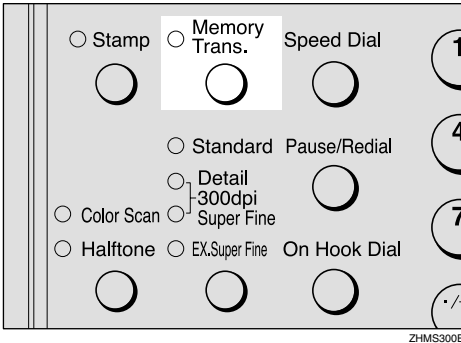

Note
If the **Memory Trans.** indicator is not lit, press the **[Memory Trans.]** key to change back to Memory Transmission.

2 Set the original and adjust the scan settings as necessary.

Note
Originals are sent at Detail resolution even if 300dpi, Super Fine, or Extra Super Fine is selected.

3 Press the **[Trans. Option]** key.

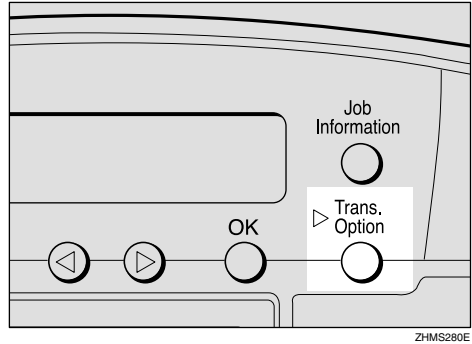

4 Press the **[Left]** or **[Right]** key to display "9. Transfer Request", and then press the **[OK]** key.



Note
If you want to make Mail Options settings, follow steps **2** to **3** of p.74 "Transmitting Internet Fax".

5 Press the **[Left]** or **[Right]** key to select "On".



6 Press the **[OK]** key.



7 Enter a Transfer Station.

! Limitation

- When an originator requests transfer by e-mail to a station that is not capable of performing transfers, the station addressed receives the request as ordinary e-mail and does not transfer it or return an Error Report to the originator of the request. Before sending e-mail, confirm that the Transfer Station is equipped with the Transfer function.

Note

- You can also specify the IP-Fax destination. See p.100 "Transmitting IP-Fax".

Entering an E-mail Address Stored in a Quick Dial Key

- 1 Press the Quick Dial key in which the recipient's mail address is stored.

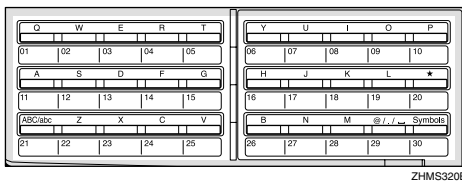

Transf. Stn.: Press OK
 001 NEWYORK BRANCH

Entering an E-mail Address Stored in a Speed Dial

- 1 Press the **[Speed Dial]** key.

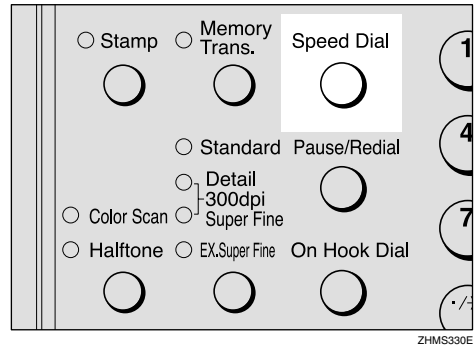

- 2 Enter the speed dial code in which the recipient's mail address is stored using the number keys.

Transf. Stn.: Press OK
 001 HEAD OFFICE

Entering an E-mail Address Manually

- 1 Press the user function key (**[F1]** to **[F10]**) assigned to the Internet FAX function.

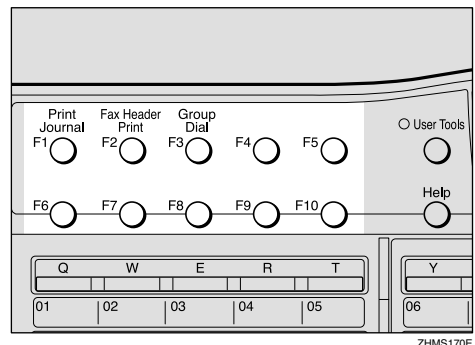

Address: [abc]

Note

- The Internet FAX function is pre-assigned to the **[F5]** key.

- If the Network Transmission Auto Check function is set to "Off" with user parameters, press the **[⏪]** or **[⏩]** key to select "1. Mail Address", and then press the **[OK]** key. For information about changing this setting, see p.166 "User Parameters" (switch 32, bit 1).

- ② Enter the mail address of the Transfer Station.



Address: [abc] /OK
nicf1@abc.company.com

Note

- If you make a mistake, press the **[Clear/Stop]** key, and then try again.
- You can enter "." and "@" with the Quick Dial keys. Press the **[Symbols]** key when you want to enter other symbols. Use the **[ABC/abc]** key to shift between uppercase and lowercase characters.

- ③ Press the **[OK]** key.

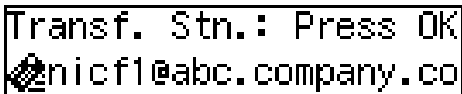

Transf. Stn.: Press OK
nicf1@abc.company.co

- ⑧ Press the **[OK]** key.



Receive Stn.:
1 [#■■■■■■■■■■■■■■■■]

- ⑨ Enter the End Receiver.



Receive Stn.: Press OK
1 [#01■■■■■■■■■■■■■■■]

Specify the End Receiver by using the Quick Dial key, Speed Dial and Group registered in Transfer Station.

Reference

p.86 "Specifying End Receivers"

- ⑩ Press the **[OK]** key.

- ⑪ Press the **[⏪]** or **[⏩]** key to select "No", and then press the **[OK]** key.

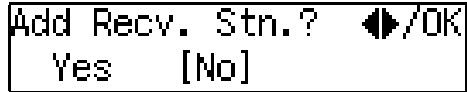

Add Recv. Stn.? ◀/OK
Yes [No]

Note

- If you want to add End Receivers, select "Yes", press the **[OK]** key, and then repeat steps 9 to ⑩.

- ⑫ Press the **[Start]** key.

This starts reading the document into memory. The e-mail is sent to the Transfer Station after the read operation is complete. The Communicating indicator is lit while a send operation is in progress.

Specifying End Receivers

You can only specify End Receivers already programmed in a Quick Dial key, Speed Dial, or Group Dial of the designated Transfer Station.

❖ Quick Dial

Enter the number (two or three digits) of the Quick Dial where the End Receiver is stored. For example, to choose the number stored in Quick Dial 001 in the Transfer Station, enter: **[0][0][1]**.

Note

- If the Transfer Station only supports two digits for the Quick Dials, enter the number with two digits like **[0][1]**.

❖ Speed Dial

Enter **[*]** followed by the Speed Dial code (two or three digits).

For example, to select the number stored in Speed Dial 012 in the Transfer Station, enter: **[*][0][1][2]**.

 Note

- If the Transfer Station only supports 2 digits for the Speed Dials, enter the number with two digits like, **[*][1][2]**.

❖ Group Dial

Enter **[*]**, **[*]** followed by the Group number (2 digits).

For example, to select the number stored in Group 04 in the Transfer Station, enter: **[*][*][0][4]**.

Receiving Internet Fax

There are two methods of receiving e-mail: Auto Mail Reception and Manual Mail Reception.

Limitation

- Documents sent from computers as e-mail attachments cannot be received. Senders receive an Error Mail Notification if their e-mail contains attachments. You can select whether or not the machine sends this message with user parameters. See p.166 "User Parameters" (switch 16, bit 3). However, TIFF-F documents created by the Saving function of LAN-Fax Driver can be received.

Note

- With user parameters, you can have the machine retain incoming mail or delete it from the POP server. See p.166 "User Parameters" (switch 16; bit 1, 0).
- With user parameters, you can have the machine return the acknowledgment of mail to the sender. See p.166 "User Parameters" (switch 17, bit 2).

Auto Mail Reception

When this function is turned on, NIC FAX periodically checks the e-mail server for incoming e-mail and downloads it as necessary. You can set this function to "On" or "Off" by following p.43 "Auto Mail RX (Auto Mail Reception)" of the "Network" settings, or by assigning the Auto Mail Reception function to a user function key and specifying "On" or "Off".

The interval between checks is referred to as Mail RX Interval (Mail Reception Interval). You can specify the interval to any value between 1 and 60 minutes, and can also force NIC FAX to check for incoming e-mail by pressing the user function key assigned to the Mail Reception function or the **【Job Information】** key. See p.88 "Manual Mail Reception".

You can also configure this feature to work in conjunction with the Night Timer so that Auto Mail Reception does not occur at times when NIC FAX is saving energy. See p.166 "User Parameters" (switch 16, bit 4), and Chapter 7 "Energy Save Timer", *Advanced Features*.

Note

- If the indicator of the user function key assigned to the Auto Mail Reception function is not lit, automatic e-mail reception will not take place. See Chapter 6 "User Function Keys", *Advanced Features*.
- If memory runs out, e-mail will not be received at the specified intervals. Reception will resume when sufficient memory becomes available.

Manual Mail Reception

Follow these steps at any time to check for incoming e-mail immediately.

Preparation

To receive e-mail by the Manual Mail Reception key, you need to assign the Manual Mail Reception function (Mail Reception) to a user function key beforehand. See p.25 "Assigning User Function Keys".

Receiving E-mail with the Mail Reception Function

- 1 Press the user function key ((F1) to (F10)) assigned to the Mail Reception function.

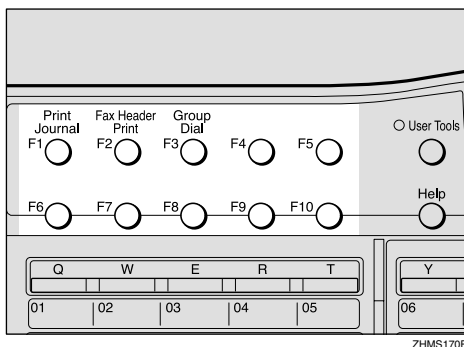

```
Mail Reception:
Press Start
```

- 2 Press the [Start] key to check for e-mail.

After checking the server, the machine receives e-mail, if there is any.

If there is no e-mail, the following display appears. Press the [OK] key.

```
No Mail Received
Press OK
```

Note

- If there is e-mail, the Communicating indicator will light and the e-mail will be printed.

- 3 Press the [Job Information] key.
The standby display reappears.

Receiving E-mail with the Job Information Function

- 1 Press the [Job Information] key.

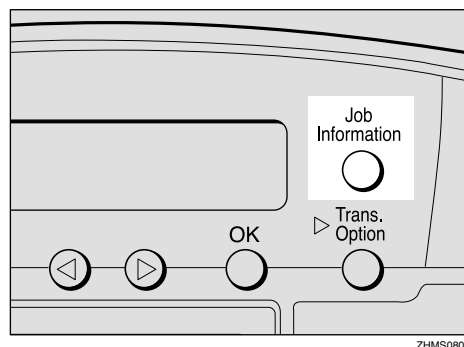

- 2 Press the ◀ or ▶ key to display "12. Mail Reception".

```
Job Information:
12. Mail Reception
```

- 3 Press the [OK] key.

```
Mail Reception:
Press Start
```

- 4 Press the [Start] key.

The machine accesses the server to check whether there is e-mail. If there is, it is received.

If there is no e-mail, the following display appears. Press the [OK] key.

```
No Mail Received
Press OK
```

Note

- If there is e-mail, the Communicating indicator will light and the e-mail will be printed.

- 5 Press the [Job Information] key.
The standby display reappears.

Receiving Transfer Request E-mail

When the machine receives Transfer Request e-mail, it transfer faxes to all the End Receivers specified in the e-mail.

Note

- You must register Polling ID and End Receivers.
- End Receivers must be programmed into Quick Dial keys, Speed Dials, or Groups in the Transfer Station (this machine). You can specify e-mail addresses as End Receivers.
- The transferred originals are printed in the Transfer Station.
- NIC FAX can receive the transfer request when the Internet Fax or IP-fax destination is specified as Transfer Station.

4

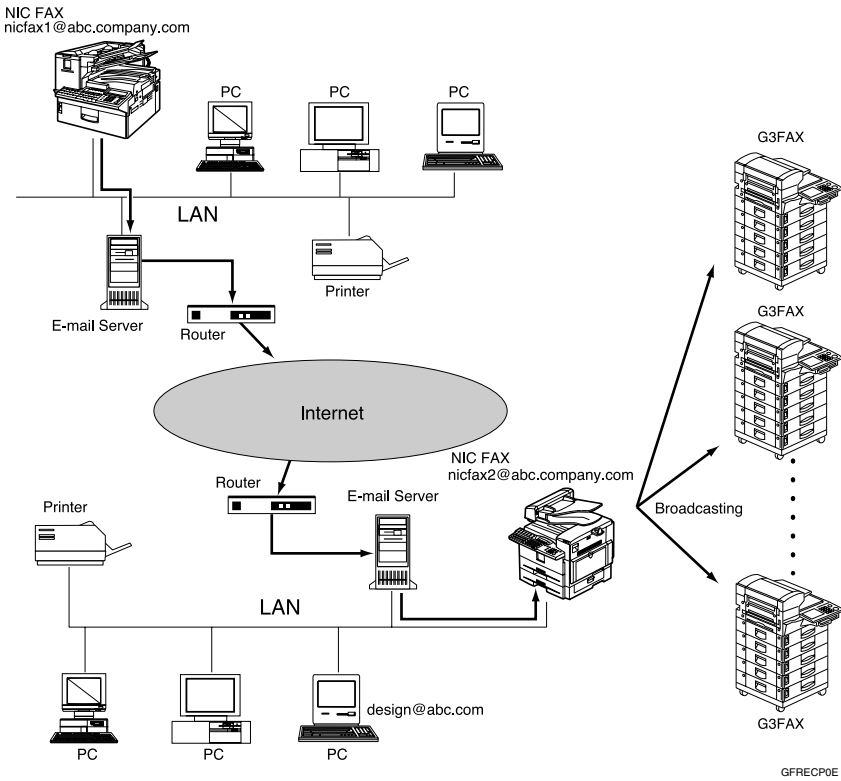

When NIC FAX (nicfax2@abc.company.com) receives Transfer Request e-mail from another NIC FAX (nicfax1@abc.company.com), it transfers the faxes to the specified End Receivers.

Routing Received Documents

When a document is received, its SUB code is compared to user codes registered in Personal Boxes and, if a match is found, the document is routed to the destination whose user code is specified. If the destination specified is an e-mail address, the received document is routed to that destination as e-mail.

At the same time, you can make the settings that all documents which do not have the SUB code are routed to the specified e-mail address by the Forwarding function. For details, see p.92 "Forwarding Received Documents".

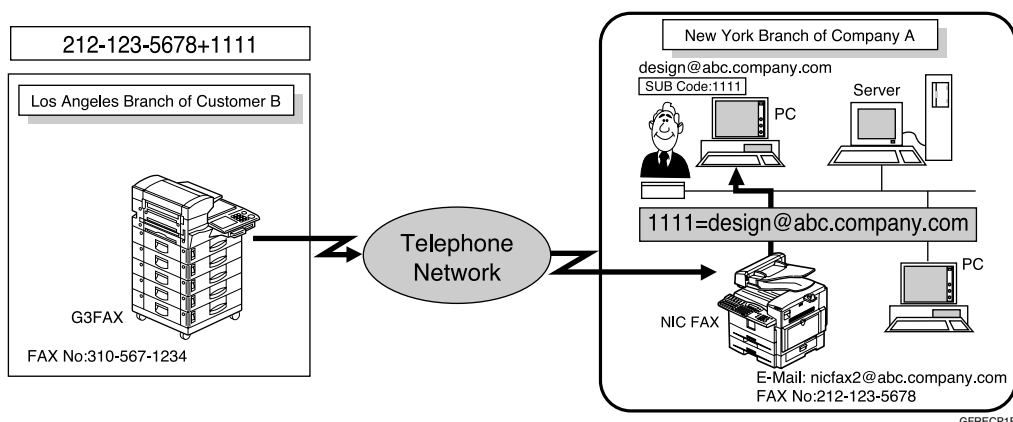

Note

- You can route documents received from any fax machine, regardless of manufacturer.
- Before routing received documents, you must set up a Personal Box and routing address. See Chapter 7 "Programming / changing Personal Boxes", *Advanced Features*.

Transferring Received Documents

Originals sent with a SUB code that matches the SUB code registered as a Transfer Box are received then relayed to the registered receiver.

When e-mail addresses are registered in the Transfer Station as receivers, received messages are sent in an e-mail format to the receivers.

Preparation

Transfer Boxes and End Receivers must be set up in order to transfer received documents. See Chapter 7 "Programming / changing Transfer Boxes", *Advanced Features*.

Note

- Transfer Results are not sent back to Transfer Requesters.
- You can transfer data received from any fax machine, regardless of manufacturer.

Forwarding Received Documents

NIC FAX can automatically forward received documents to other destinations registered in memory based on Own Name, Own Fax Number or sender's e-mail address. If an e-mail address is registered as the destination, documents received are forwarded as e-mail.

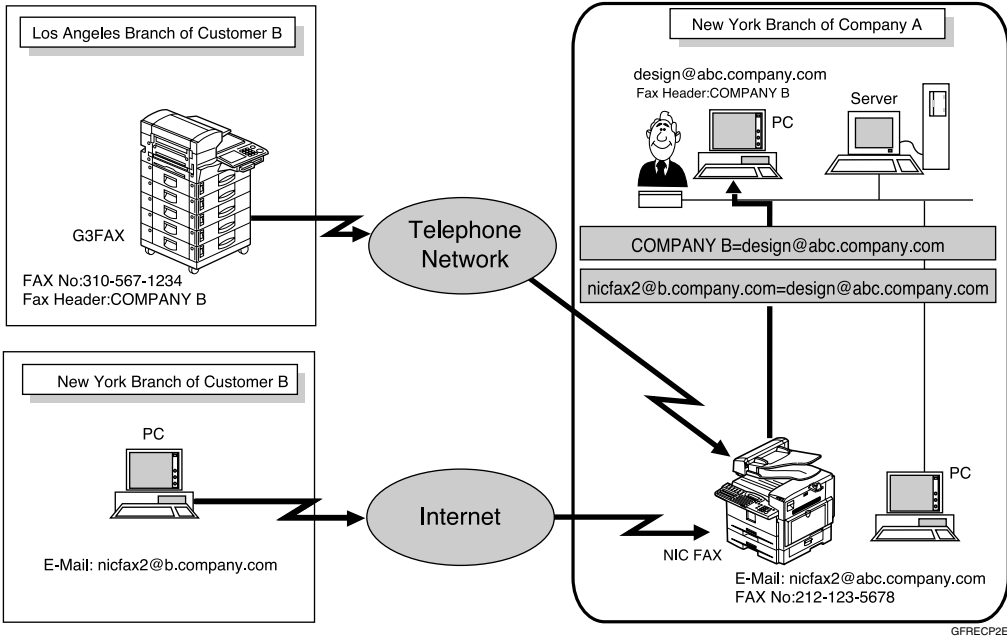

Note

- You need to specify the Forwarding destination in advance. See Chapter 7 "Forwarding", *Advanced Features*.
- You can select whether the machine prints out the messages it forwards with user parameters (switch 11, bit 6). For details, see Chapter 7 "User Parameters", *Advanced Features*.
- If you do not specify Own Name, Own Fax Number or sender's e-mail address, all documents are forwarded to the registered destination. For details, see Chapter 7 "Forwarding", *Advanced Features*.

SMTP Reception

NIC FAX ordinarily uses POP e-mail reception, but can be set to use SMTP reception.

With POP reception, e-mail is received using Auto Mail Reception or Manual Reception.

With SMTP reception, e-mail is received as soon as it is sent to the e-mail address set by NIC FAX. You can route received e-mail to other Internet fax machines also.

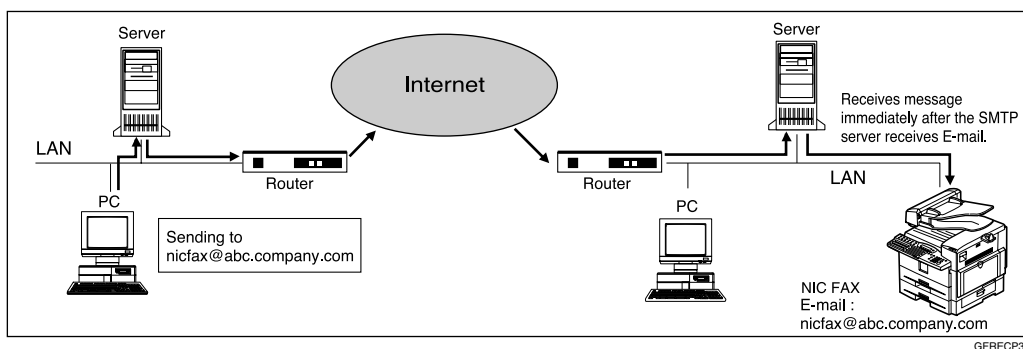

Note

- ❑ DNS server settings must be made before using SMTP reception. See p.73 “E-mail Server Settings (by Network Administrator)”.
- ❑ To use SMTP reception, SMTP reception must be set to "On" as described in p.166 “User Parameters” (switch 17, bit 0).
- ❑ Even if SMTP reception is enabled on the DNS server, mail sent from the SMTP server will not be received and NIC FAX reports an error if SMTP reception is set to "Off" with user parameters. Also, the SMTP server sends an error notification to the originator.
- ❑ If an error is encountered during e-mail reception, reception is aborted, the e-mail is discarded, and Error Report is printed. Also, the SMTP server sends an error notification to the originator.
- ❑ SMTP reception cannot be interrupted by pressing the **[Clear/Stop]** key.
- ❑ When the SMTP server attempts to route received documents to NIC FAX while NIC FAX is transmitting an e-mail, NIC FAX will respond to the SMTP server with a "busy" signal. Then, the SMTP server usually tries resending the documents until the set timeout.

Reference

- p.88 “Auto Mail Reception”
- p.88 “Manual Mail Reception”
- p.94 “Routing Mail Received via SMTP”

Routing Mail Received via SMTP

Mail received via SMTP can be routed to other fax machines. It can also be routed to destinations registered as Quick Dial entries, Speed Dial entries, or Groups.

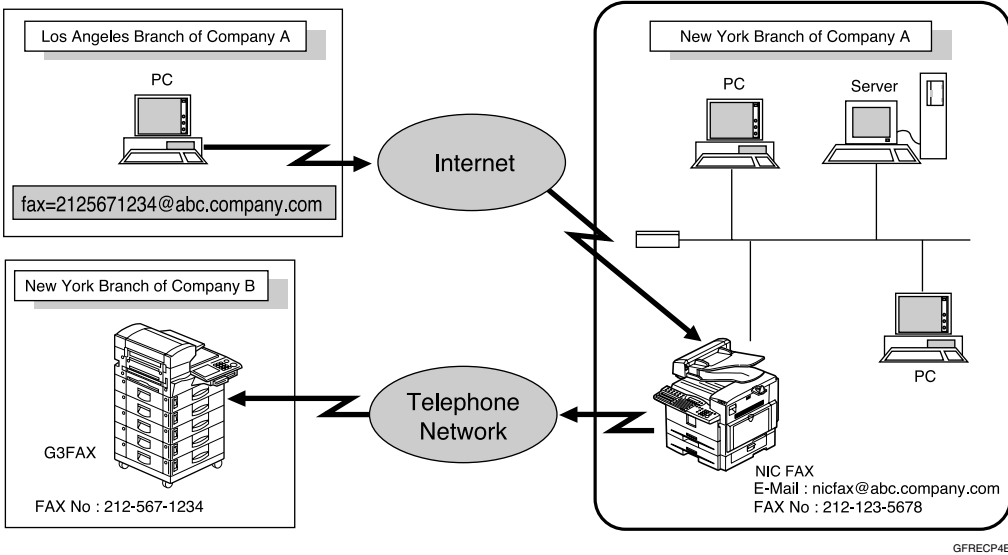

4

Preparation

Before routing mail received via SMTP, you first must set "Route documents received with SMTP" to "Yes" with user parameters. See p.166 "User Parameters" (switch 17, bit 1).

Note

- If a mail transfer request is received when the "Route documents received with SMTP" with user parameters is set to "No," NIC FAX responds with an error message to the SMTP server.
- You can make settings that limit transfer to specified originators. See p.42 "Auth. E-Mail RX (Authorized E-mail Reception)".
- Using this function, you can also send documents from your e-mail software to e-mail addresses and G3 fax machines' destinations through NIC FAX simultaneously. For details about specifying the destinations of fax machines, see the following.

 **Specifying Mail Transfer**

The originator can request transfer of mail sent to another NIC FAX by specifying the e-mail address as follows:

❖ Fax Number

fax=destination fax number@host name of NIC FAX. domain name

Example: to transfer to fax number 212-123-4567, specify:

fax=2121234567@nicfax.abc.company.com

❖ Quick Dial Destination

fax=#Quick Dial key number@host name of NIC FAX.domain name

Example: to transfer to the destination registered under Quick Dial key 01:

fax=#01@nicfax.abc.company.com

❖ Speed Dial Destination

fax=#*Speed Dial number@host name of NIC FAX.domain name

Example: to transfer to the destination registered under Speed Dial number 12:

fax=#*12@nicfax.abc.company.com

❖ Group Destination

fax=***Group number@host name of NIC FAX.domain name

Example: to transfer to the destination registered under Group number 04:

fax=***04@nicfax.abc.company.com

Canceling Transmission of an Internet Fax

While the Original is Being Scanned In

1 Press the **[Clear/Stop]** key.

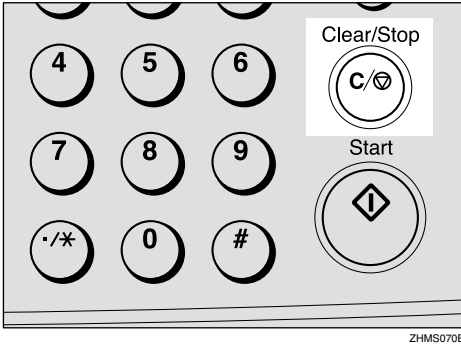

The machine will stop storing the original and the data will not be sent.

After the Original Has Been Scanned In

Limitation

You cannot cancel transmission of a message after it has been sent. Messages not shown in the file list have been already sent. See Chapter 2 "Printing a List of Files in Memory (Print TX File List)", *Advanced Features*.

1 Press the **[Job Information]** key.

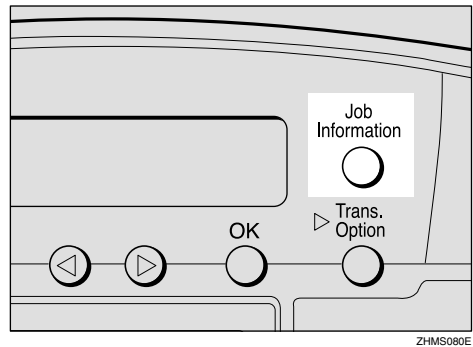

2 Confirm "1. Cancel TX / RX (Cancel Transmission / Reception)" appears, and then press the **[OK]** key.

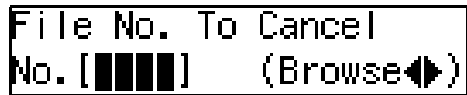

3 Press the **[Left]** or **[Right]** key to display the message you want to delete.

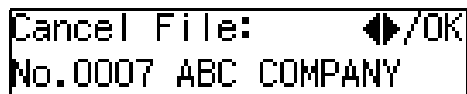

4 Press the **[OK]** key.

5 Press the **◀** or **▶** key to select "Yes".

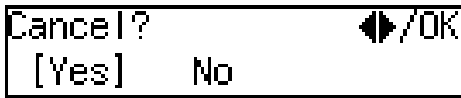

 **Note**

- If you do not want to cancel transmission, select "No".

6 Press the **[OK]** key.

The standby display reappears.

 **Standby documents under forwarding**

Although received transfer request documents and standby documents under forwarding are displayed in the display of step **5**, you cannot delete these documents.

5. Using IP-Fax Functions

IP-Faxing enables you to send fax messages via networks that use TCP/IP such as LAN or Internet. The transmission procedure for IP-Faxing is almost the same as that for conventional fax transmission.

The functions used for conventional fax transmission are also available for IP-Fax with similar operation procedures.

You can also send fax messages through your network to ordinary G3 fax machines connected to the public telephone lines by using VoIP gateways (with T.38 Function).

Note

- In case of transmission via the Internet, the equipment on the receiving end must be connected directly to the Internet. The equipment is not accessible if it is connected to a network which is protected by installing Firewall.
- You can specify IP-Fax destinations as Transfer Station making a Transfer Request. See p.84 "Transfer Request by E-mail".
- For information about VoIP gateways (with T.38 Function) or gatekeepers that have been confirmed to work, contact your dealer or service representative.
- When you send IP-Fax specifying a user code (only in the Memory Transmission) and the e-mail address is set as the routing destination of the specified user code, a Communication Result Report is sent after the transmission is completed. This makes it possible to verify the result of a transmission. See p.176 "Communication Result Report".

Transmitting IP-Fax

Transmitting by Specifying an IP Address or Host Name

This section describes how to send fax messages to an IP-Fax connected to the same LAN or connected directly to the Internet.

- 1** Set the original, and then select the scan settings as necessary.
- 2** Press the user function key (**[F1]** to **[F10]**) assigned to the Internet FAX function.

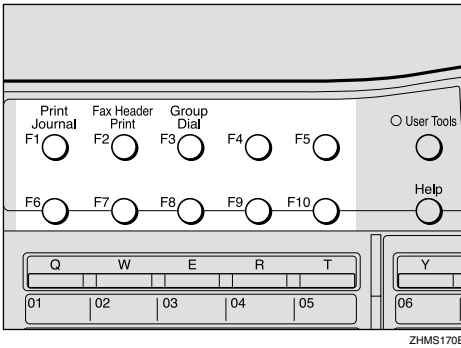

The display for entering an address appears.

Note

- The Internet FAX function is pre-assigned to the **[F5]** key.
- Use the following to specify an IP address or host name without pressing the user function key:
 - Quick Dial, Speed Dial, or Group Dial assigned to the destination IP address
 - The Redial function

Reference

- Chapter 2 "Dialing", *Basic Features*
- Chapter 3 "Redial", *Advanced Features*

If the Network Transmission Auto Check Function Is Turned Off

If the Network Transmission Auto Check function is set to "Off" with user parameters, select "IP-Fax Address" in the display that appears. For information on changing this setting, see p.166 "User Parameters" (switch 32, bit 1).

- 1** Press the **[Left]** or **[Right]** key to select "2. IP-Fax Address".



- 2** Press the **[OK]** key.

- 3** Enter the IP address or host name of the destination, and then press the **[OK]** key.

When the Network Transmission Auto Check Function is set to On:



When the Network Transmission Auto Check Function is set to Off:



Note

- When specifying a destination using IP address, you may need to give the port number too, depending on network settings at the receiving end. For example, if the destination IP address is 192.168.1.10 and the port number is 2100, you should identify the destination as 192.168.1.10:2100. Contact your network administrator for details.

- ❑ When specifying a destination using the host name, you may need to give the port number too, depending on network settings at the receiving end. For example, if the destination host name is "abc.company.com" and the port number is 2100, you should identify the destination as "abc.company.com:2100". Contact your network administrator for details.
- ❑ When specifying a destination using host name, set the DNS Server Address beforehand.
- ❑ To enter texts registered in "Template: Address", press the **[★]** key, press the **[◀]** or **[▶]** key to display the desired text, and then press the **[OK]** key. See p.147 "Registering Template Addresses".

- 4** Press the **[◀]** or **[▶]** key to display "2. IP-Fax Address".

```
Network TX Option
2. IP-Fax Address
```

Note

- ❑ If the Network Transmission Auto Check function is turned off, the display does not appear. Proceed to step **6**. See p.166 "User Parameters" (switch 32, bit 1).

- 5** Press the **[OK]** key.

```
Dest.1      Press Start
<->192.168.1.10
```

- 6** If you want to specify another destination, press the **[OK]** key, and then repeat steps **2** to **5**.

Note

- ❑ If you do not want to specify other destination, proceed to step **7**.

- 7** Press the **[Start]** key.

IP-Fax transmission begins.

Transmitting by Specifying a VoIP Gateway

This section describes how to send fax messages through your network to ordinary G3 fax machines connected to the public telephone lines via a VoIP gateway.

- 1** Set the original, and then select the scan settings as necessary.

- 2** Press the user function key (**[F1]** to **[F10]**) assigned to the Internet FAX function.

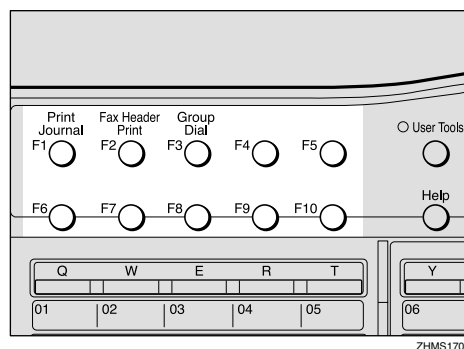

The display for entering an address appears.

Note

- ❑ The Internet FAX function is pre-assigned to the **[F5]** key.
- ❑ Use the following to specify an IP address or host name without pressing the user function key:
 - Quick Dial, Speed Dial or Group Dial assigned to the destination IP address
 - The Redial function

Reference

Chapter 2 "Dialing", *Basic Features*

Chapter 3 "Redial", *Advanced Features*

If the Network Transmission Auto Check Function Is Turned Off

If the Network Transmission Auto Check function is set to "Off" with user parameters, select "IP-Fax Address" in the display that appears. For information about changing this setting, see p.166 "User Parameters" (switch 32, bit 1).

5

- 1 Press **⏪** or **⏩** key to display "2. IP-Fax Address".



- 2 Press the **[OK]** key.

- 3 Enter the G3 fax number of the receiver using the number keys, and then press the **[OK]** key.

When the Network Transmission Auto Check Function is set to On:



When the Network Transmission Auto Check Function is set to Off:

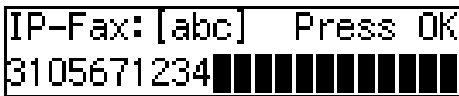

- 4 Press the **⏪** or **⏩** key to display "2. IP-Fax Address".

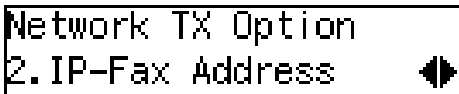

Note

- ❑ If the Network Transmission Auto Check function is turned off, the display does not appear. Proceed to step 6. See p.166 "User Parameters" (switch 32, bit 1).

- 5 Press the **[OK]** key.

- 6 Press the **⏪** or **⏩** key to select "Yes".



- 7 Press the **[OK]** key.

The display for entering the VoIP gateway address appears.

- 8 Enter the IP address or host name of the VoIP gateway.

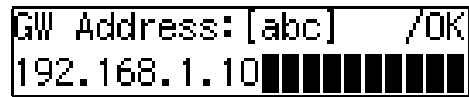

- 9 Press the **[OK]** key.



- 10 If you want to specify another destination, press the **[OK]** key, and then repeat steps 2 to 9.

Note

- ❑ If you do not want to specify other destination, proceed to step 11.

- 11 Press the **[Start]** key.

The IP-Fax transmission begins.

Transmitting by Specifying an Alias Fax Number

This section describes how to send fax messages by specifying an alias fax number of a destination stored in the gatekeeper.

Preparation

You need to set the gatekeeper address as well as alias fax number beforehand with IP-Fax Parameter settings. See p.43 "IP-Fax Parameter Settings".

Also, you need to make settings for using the gatekeeper for IP-Fax transmission with user parameters. For information about making these settings, see p.166 "User Parameters" (switch 32, bit 0).

Note

- Alias fax numbers are fax numbers stored in the gatekeeper and valid only within the network.
- If you change the settings for using or not using the gatekeeper, you need to program the destinations for the Quick Dial or Speed Dial again. Normal IP-Fax transmission is not possible without performing this procedure.

- 1** Set the original, and then select the scan settings as necessary.

- 2** Press the user function key (**[F1]** to **[F10]**) assigned to the Internet FAX function.

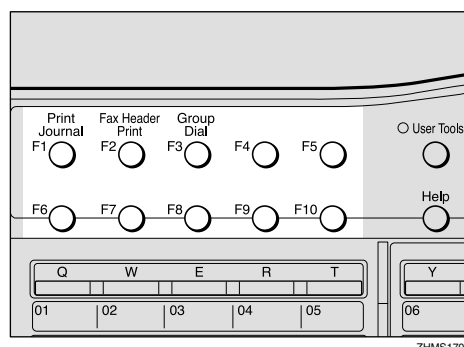

The display for entering an address appears.

Note

- The Internet FAX function is pre-assigned to the **[F5]** key.
- Use the following to specify an alias fax number without pressing the user function key:
 - Quick Dial, Speed Dial or Group Dial, assigned to the destination IP address
 - The Redial function

Reference

Chapter 2 "Dialing", *Basic Features*

Chapter 3 "Redial", *Advanced Features*

If the Network Transmission Auto Check Function Is Turned Off

If the Network Transmission Auto Check function is set to "Off" with user parameters, select "IP-Fax Address" in the display that appears. For information about changing this setting, see p.166 "User Parameters" (switch 32, bit 1).

- 1 Press the **⏪** or **⏩** key to select "2. IP-Fax Address".



- 2 Press the **[OK]** key.

- 3 Enter the alias fax number of the destination using the number keys, and then press the **[OK]** key.

When the Network Transmission Auto Check function is set to "On":



When the Network Transmission Auto Check function is set to "Off":



- 4 Press the **⏪** or **⏩** key to display "2. IP-Fax Address".



Note

- If the Network Transmission Auto Check function is turned off, the display does not appear. Proceed to step 6. See p.166 "User Parameters" (switch 32, bit 1).

- 5 Press the **[OK]** key.

- 6 Confirm "Yes" is selected, and then press the **[OK]** key.

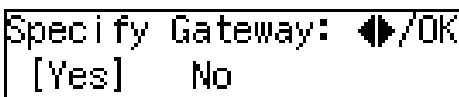

The display for entering the VoIP gateway address appears.

Note

- If you do not use the gateway, select "No", press the **[OK]** key, and then proceed to step 9.

- 7 Enter the alias fax number registered on the gatekeeper.



Reference

p.44 "Own Fax Number (Alias Fax Number)"

- 8 Press the **[OK]** key.



- 9 If you want to specify another destination, press the **[OK]** key, and then repeat steps 2 to 8.

Note

- If you do not want to specify other destination, proceed to step 10.

- 10 Press the **[Start]** key.

The IP-Fax transmission begins.

Canceling Transmission of an IP-Fax

While the Original Is Being Scanned In

To cancel IP-Fax transmission while scanning is in progress, perform the procedure described below.

- 1 Press the **[Clear/Stop]** key.

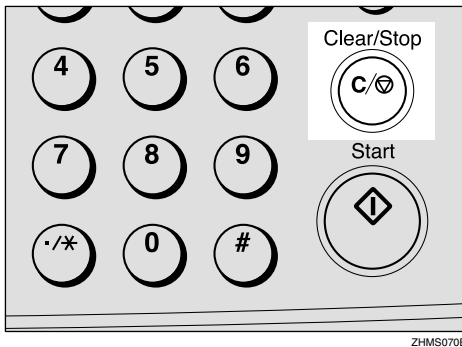

The machine will stop storing the original and the data will not be sent.

After the Original Has Been Scanned In

To cancel IP-Fax transmission after scanning is complete, perform the procedure described below.

! Limitation

- ❑ You cannot cancel a transmission that has already been performed. If a file is not in the List of Files in Memory, it has already been transmitted. See Chapter 2 "Printing a List of Files in Memory (Print TX File List)", *Advanced Features*.

- 1 Press the **[Job Information]** key.

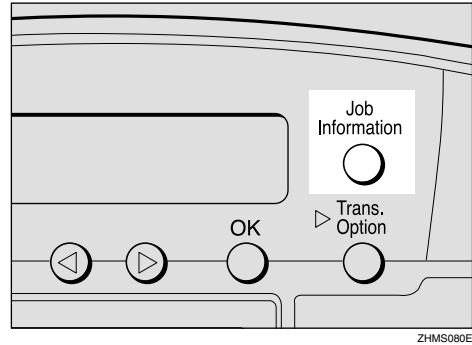

```
Job Information:
1.Cancel TX / RX
```

- 2 Confirm "1.Cancel TX / RX (Cancel Transmission / Reception)" appears, and then press the **[OK]** key.

```
File No. To Cancel
No. [■■■■] (Browse◀▶)
```

If there are any files stored in memory, the file information is displayed.

- 3 Press the **◀** or **▶** key until the file you want to delete appears.

```
Cancel File: ◀▶/OK
No.0007 ABC COMPANY
```

- 4 Press the **[OK]** key.

- 5 Press the **◀** or **▶** key to select "Yes".

```
Cancel? ◀▶/OK
[Yes] No
```

✎ Note

- ❑ To cancel deletion, select "No".

6 Press the **[OK]** key.

7 Press the **[Job Information]** key.

The standby display reappears.

6. Using LAN-Fax Functions

Basic Transmission

This section describes how to send fax documents created using computer applications.

Open the document you want to send, or create a new document using an application, and then perform the following procedure.

Note

- You can specify up to 100 destinations.
- NIC FAX can communicate with up to three computers on the network simultaneously.
- Set the resolution for transmission with the Properties setting for LAN-Fax beforehand. See p.114 “Setting LAN-Fax Properties”.
- By programming your own e-mail address as a destination in the user codes, you can have a Communication Result Report sent to that address by specifying it when you transmit using LAN-Fax. This makes it possible to verify the results of transmission. See p.176 “Communication Result Report”.

1 On the [File] menu, click [Print].

2 Click [LAN-Fax F3] in [Printer Name], and then click [OK].

The [LAN-Fax] dialog box appears.

Note

- The setting method may vary depending on the application you are using. In all cases, select [LAN-Fax F3] for the printer.

3 Specify the destination.

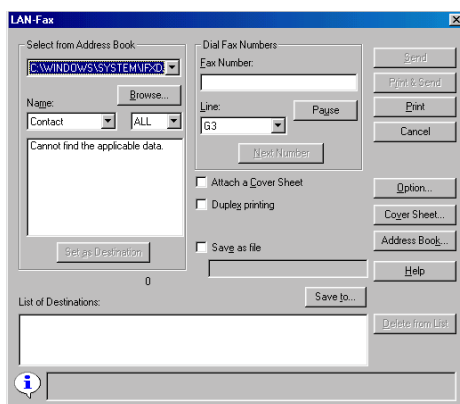

Use either one of the following procedures to specify the destination:

Directly Entering the Fax Number

1 In the [Fax Number] box, enter the destination's fax number .

Note

- To enter a pause (-), click [Pause] (the first digit cannot be a pause).
- For details about functions other than the pause function, see the online Help.

2 If you want to specify another destination, click [Next Number] and repeat step **1**.

Specifying the Destination by Entering a Quick Dial, Speed Dial, or Group code

1 Enter a destination already stored on your NIC FAX in the [Fax Number] text box, following the instruction below.

❖ Quick Dial

Enter **【#】** followed by the Quick Dial code (two digits). For example, to specify the end receiver assigned to Quick Dial code 01, enter: **【#】【0】【1】**.

❖ Speed Dial

Enter **【#】**, **【*】** followed by the Speed Dial code (three digits). For example, to specify the end receiver assigned to Speed Dial code 012, enter: **【#】【*】【0】【1】【2】**.

❖ Groups

Enter **【#】【*】**, **【*】** followed by the 2-digit Group code. For example, to specify the end receiver assigned to Group code 04, enter: **【#】【*】【*】【0】【4】**.

📝 Note

- If an attachment is registered to specified Quick Dial key, it cannot be transmitted. See Chapter 6 "Auto Documents", *Advanced Features*.

- ② If you want to specify another destination, click **【Next Number】** and repeat step ③.

Specifying a Destination from Address Book

- ① Click the ▼ button to the right of the **【Select from Address Book】** selector, select a destination in the list that appears, and then click **【Set as Destination】**.

📝 Note

- Destinations must be stored in the list of destinations using Address Book beforehand. See p.110 "Address Book".
- Click **【Address Book】** to start up Address Book.

- ② If you want to specify another destination, repeat step ③.

④ Specify options as necessary.

If you do not want to specify any options, proceed to step ⑤.

Attaching a Cover Sheet

- ① Select the **【Attach a Cover Sheet】** check box.

📝 Note

- If you specify this setting, a cover sheet is attached in front of the document you are sending. To edit the cover sheet, click **【Cover Sheet】**. For details, see online Help.

Specifying Options

You can specify the following options:

- Sending at Specific Time
- User Code Transmission
- User ID
- Fax Header Print

- ① Click **【Option】**.
- ② Specify options.

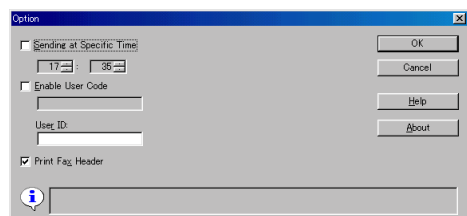

❖ To Select Sending at Specific Time

Select the **[Sending at Specific Time]** check box, and then specify the transmission time.

❖ To Select User Code Transmission

Select the **[Enable User Code]** check box to select the box, and then enter the user code (SUB code for Personal Box) into the text box.

Entering the user code is necessary if Restricted Access is specified on your NIC FAX.

❖ To Select Fax Header Print

Select the **[Print Fax Header]** check box.

Reference

Chapter 1 "Restricted Access Display", *Basic Features*

Chapter 1 "Sending at a Specific Time (Send Later)", "User Code Transmission", "Fax Header Print", and Chapter 7 "Programming / changing Personal Boxes", *Advanced Features*

3 Click **[OK]**.

5 Click **[Send]**.

Note

- Click **[Print&Send]** to send the document and print a local copy.
- Click **[Print]** to print a copy of the document you specified without sending it.

Managing Transmissions from LAN-Fax Driver

You can manage transmissions from LAN-Fax Driver using SmartDeviceMonitor for Admin and SmartDeviceMonitor for Client.

You can check the following information you sent with LAN-Fax Driver.

- User ID
- Status
- Pages (Number of pages)
- Started At (Start time)
- File No.

Note

- When using SmartDeviceMonitor for Admin, double-click NIC FAX on the Group window, and then click the **[Job History]** tab of the information window.
- When you use SmartDeviceMonitor for Client, register NIC FAX as network device first. Double-click NIC FAX on the Status window, and then click the **[Job History]** tab of the information window.
- If an error occurs during transmission or printing, "0" appears as the page number, even when part of a document is transmitted or printed.
- If renewing the display is attempted from another computer at the same time, it may not be successful. If this happens, try it again.

Reference

For details about using SmartDeviceMonitor for Admin and SmartDeviceMonitor for Client, see their respective online Help.

Address Book

You can store and edit entries in the list of destinations using Address Book.

Note

- ❑ Address Book is saved as a CSV file. You can register 2000 addresses in a CSV file, and specify destinations using multiple CSV files.
- ❑ For detailed information, see the online Help.

1 On the task bar, first click **[Start]**, point to **[Programs]**, point to **[LAN-Fax Utilities]**, and then click **[Address Book]**.

The Address Book display appears.

2 Edit an existing destination, or store a new one.

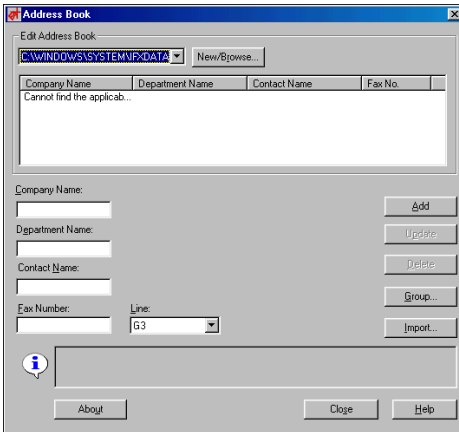

Note

- ❑ You can store destinations in groups. Click **[Group]** to start the procedure.

Storing a New Destination

1 Enter the destination.

Note

- ❑ You can enter data for the following items: Company Name, Department Name, Contact Name, and Fax Number. To register a new destination, Contact Name and Fax Number are required.
- ❑ For **[Line]**, select the appropriate line type from the following: G3, G3-2, G3-Dir.Auto, G3 PABX Auto. G3-3 and G4 also appear, but you cannot specify them since NIC FAX UNIT TYPE410 does not support them.

2 Click **[Add]**.

The new destination is added to the list.

Editing Stored Destinations

1 Select the destination you want to edit from the list.

The name of the company is highlighted.

2 Edit the data.

3 Click **[Update]**.

The edited destination is stored, overwriting the old data.

Deleting Stored Destinations

1 Select the destination you want to edit from the list.

The name of the company is highlighted.

2 Click **[Delete]**.

3 Click **[Yes]** in the **[Address Book]** dialog box.

3 Click **[Close]**.

4 If you have made any changes to entries in the list, the confirmation message appears. To save the changes you made, click **[Yes]**.

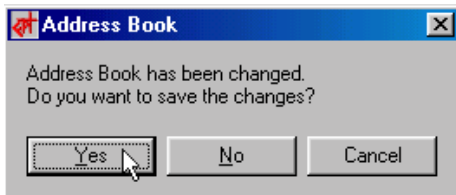

If you do not want to save the changes and quit editing, click **[No]**.

To return to the editing display, click **[Cancel]**.

 **Note**

- The dialog box shown above does not appear if you have not made any changes to the list after opening Address Book.

Printing and Saving

You can print documents created using computer applications. Instead of printing, you can also save documents as TIFF-F image files on a computer.

Open the document you want to print or save as an image file, or create a new document using an application, and then perform the following procedure.

Note

- ❑ You can select either one of four resolution settings: Standard (200 × 100 dpi), Detail (200 × 200 dpi), Super Fine (400 × 400 dpi), Extra Super Fine (600 × 600 dpi).
- ❑ In order to set resolution to Extra Super Fine, you need to install the optional 40MB memory card and make necessary settings with user parameters. For information about making this setting, see p.166 "User Parameters" (switch 20, bit 3).
- ❑ If you use the Saving function to save documents created using computer applications as image files, and send the file as e-mail attachments, they can be received by NIC FAX.

- 1** On the [File] menu, click [Print].
- 2** Click [LAN-Fax F3] in [Printer Name], and then click [OK].

The [LAN-Fax] dialog box appears.

Note

- ❑ Setting procedures may vary depending on the application you are using. In all cases, select [LAN-Fax F3] for the printer.
- 3** If you want to print on both sides of the paper, select the [Duplex Printing] check box.

Note

- ❑ If you do not want to specify Duplex Printing, proceed to step **4**.
- ❑ To specify the Duplex Printing function, click [Duplex Printing]. This setting is cleared next time you send a text.
- ❑ When you specify Duplex Printing, you need to specify the tray for which the Two-sided Printing function is turned on. For details about the Two-sided Printing function, see Chapter 6 "Paper Tray for Two-sided Printing", *Advanced Features*.

- 4** Follow either of the procedures below according to your needs.

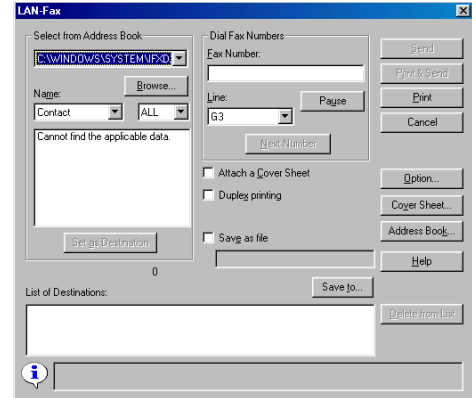

Printing from the Fax Machine

- 1** Click [Print].

Note

- ❑ If a receiver is already specified, [Print&Send] appears instead of [Print]. Click [Print&Send] to print from the fax machine and send to the destination.

Saving as File to Computer

① Select the **[Save as file]** check box.

② Click **[Save to]**.

Note

- The information about the folder you set is stored. If you want to save using the former settings, omit steps ② to ⑤ and proceed to step ⑥.

③ Specify the folder you want to save the file in.

Click the folder in the folder list that you want to save in.

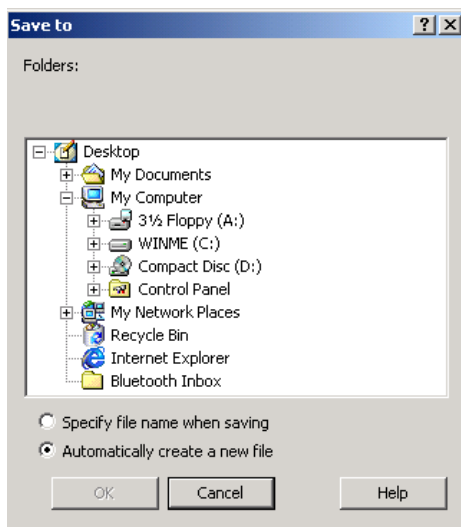

④ Click **[Specify file name when saving]** or **[Automatically create a new file]**.

Note

- If you select **[Automatically create a new file]** the file name is created in "Ric+hours, minutes and seconds.tif" format. For example, if you save at 10:40:12, the file name is "Ric104012.tif".

⑤ Click **[OK]**.

⑥ Click **[Save]**.

Note

- If a receiver is specified, **[Save_Send]** appears instead of **[Save]**. Click **[Save_Send]** to save as an image file and send to the destination.

⑦ The **[Save as]** dialog box appears. Enter a file name, and then click **[Save]**.

Note

- The dialog box appears only when you select **[Specify file name when saving]** in step ④.

Setting LAN-Fax Properties

This section describes how to make settings, such as document size, resolution, and options.

- Paper Size
- Orientation
- (Paper) Tray
- Resolution
- Gray Scale (Only with Windows 95/98/Me)
- Print as Graphics (Only with Windows 95/98/Me)
- Accessories

Note

The dialog box appearance varies according to the Windows version. The examples shown here appear with Windows 98.

1 On the task bar, click [Start], point to [Settings], and then click [Printers].

Click [LAN-Fax F3] so that it is highlighted, and then click [Properties] on the [File] menu.

The [LAN-Fax F3 Properties] dialog box appears.

Note

- Under Windows 2000/XP or Windows NT4.0, log on as a member of the Administrators group.
- With Windows NT 4.0, click [Document Default] on the [File] menu.
- With Windows 2000/XP, click [Print Settings] on the [File] menu.

2 Click the [Paper] tab.

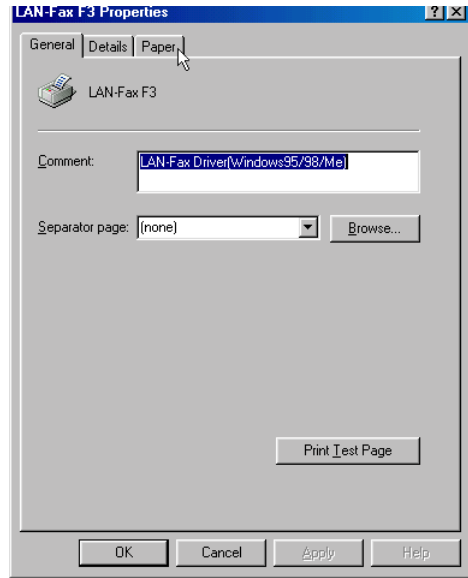

3 Make paper settings.

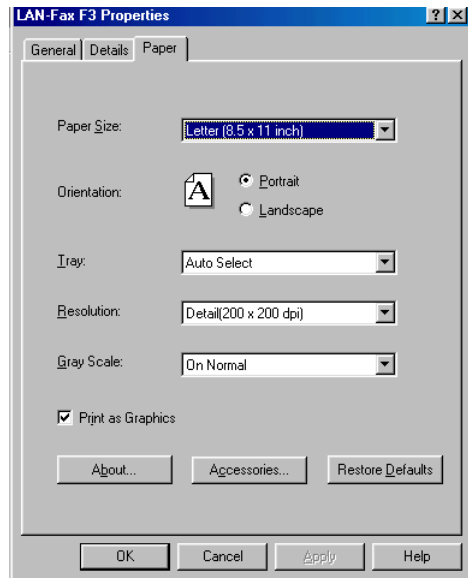

Note

- "Gray Scale" and "Print as Graphics" appears only with Windows 95, Windows 98, or Windows Me.

- To make settings for options, click [**Accessories**] and select the check boxes of the options that are installed on your NIC FAX.

4 Click [OK].

 **Editing fax cover sheets**

LAN-Fax Cover Sheet Editor allows you to edit the format of fax cover sheets. See LAN-Fax Cover Sheet Editor Help for detailed instructions.

 **Note**

- To start LAN-Fax Cover Sheet Editor, click [**Start**] on the Window's Task Bar, point to [**Programs**], [**LAN-Fax Utilities**], and then click [**LAN-Fax Cover Sheet Editor**].
- To select a created cover sheet, click [**Cover Sheet...**], and then specify a cover sheet file in [**Select Cover Sheet**].

7. Using Network Delivery Scanner Functions

You can use NIC FAX as a network scanner.

The scanned data can be sent, or delivered to destinations registered to a ScanRouter V2 Lite server or ScanRouter V2 Professional server on the network.

Note

- To use ScanRouter V2 Lite, it is necessary to make settings with user parameters. See p.166 “User Parameters” (switch 16, bit 2).
- To use ScanRouter V2 Professional, settings must be made by a customer engineer. Contact your nearest dealer.

Delivering Scanned Data

Preparation

You need to make Network settings beforehand. See p.28 “NIC FAX Initial Settings”.

You need to register this machine by I/O device settings for ScanRouter V2 Lite/Professional.

It is recommended that you program destinations in Quick Dial keys or Speed Dials beforehand, so that the operation will be easy and trouble-free. It is assumed that destinations are already programmed into Quick Dial keys or Speed Dials in the following instructions. See p.133 “Registering Addresses for Scanner”.

Note

- The scanned data is first transmitted from NIC FAX to the server, and then delivered to the specified destinations. The delivery procedure varies depending on the settings made in each server.
- The following functions are not available even if you specify them:
 - Fax Header Print
 - Label Insertion

Color Original

- 1** Make sure the Memory Trans. indicator is not lit.

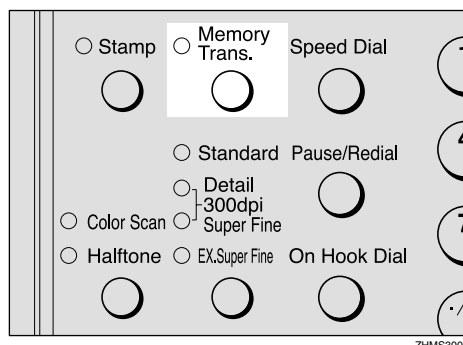

Note

- If the **Memory Trans.** indicator is lit, press the **【Memory Trans.】** key.

2 Press the **[Color Scan]** key.

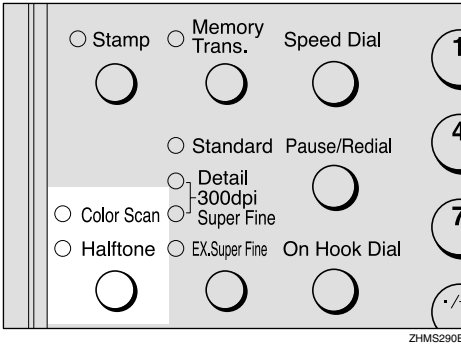

Make sure the **Color Scan** indicator is lit.

3 Press the **⏪** or **⏩** key to select the original size, and then press the **[OK]** key.

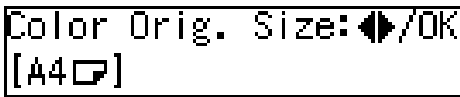

4 Set the original, and then make the scan settings as necessary.

Note

- In order to set resolution to Extra Super Fine, you need to make necessary settings with user parameters. For information about making this setting, see p.166 “User Parameters” (switch 20, bit 2).

5 Enter the destination using a Quick Dial key or Speed Dial.

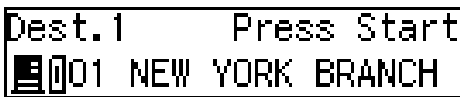

Note

- You can specify the destination using methods other than Quick Dial or Speed Dial. See p.120 “Specifying Destinations Without Using Quick Dial Keys or Speed Dials”.

6 To add one or more destinations, press the **[OK]** key, and then repeat step **5**.

Note

- If you do not want to add any other destinations, proceed to step **7**.

7 Press the **[Start]** key.

Scanning begins.

When scanning is complete, the standby display reappears, and the scanned data is transmitted to the server.

Note

- Press the **[Clear/Stop]** key to cancel scanning. If scanning is canceled, the scanned data is cleared and will not be transmitted.
- The Communication Failure Report is printed if transmission was not successful.

Monochrome Original

1 Make sure the **Memory Trans.** indicator is lit.

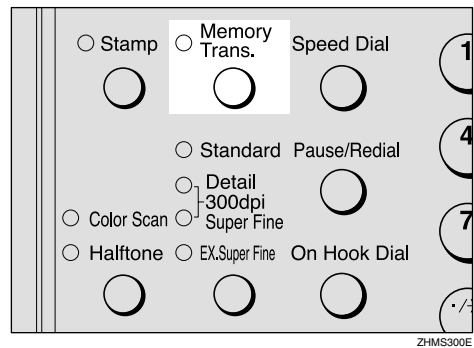

Note

- If the **Memory Trans.** indicator is not lit, press the **[Memory Trans.]** key.

2 Set the original, and then make the scan settings as necessary.

Note

- In order to set resolution to Extra Super Fine, you need to make necessary settings with user parameters. For information about making this setting, see p.166 “User Parameters” (switch 20, bit 2).

3 Enter the destination using a Quick Dial key or Speed Dial.

```

Dest.1      Press Start
┌──────────┴──────────┐
│ 01 NEW YORK BRANCH  │
└──────────┬──────────┘
  
```

Note

- You can specify the destination using methods other than Quick Dial or Speed Dial. See p.120 “Specifying Destinations Without Using Quick Dial Keys or Speed Dials”.
- If you want to specify another destination, press the **[OK]** key and repeat step 3.
- You can perform fax transmission as well as Scanner Delivery by entering a fax number as the destination.

4 Press the **[Start]** key.

Scanning begins.

When scanning is complete, the standby display reappears, and the scanned data is transmitted to the server.

Note

- Press the **[Clear/Stop]** key to cancel scanning. If scanning is canceled, the scanned data is cleared and will not be transmitted.

- Scanner Delivery stores the scanned data in memory and converts it into a file before transmission. This procedure may take a while depending on the quantity of originals.
- The Communication Failure Report is printed if transmission to any of the specified destinations was not successful.

Specifying Destinations Without Using Quick Dial Keys or Speed Dials

You can specify the destination using methods other than Quick Dial or Speed Dial, such as Groups or Redial. You can also specify destinations using the number keys.

Preparation

You need to make Network settings beforehand. See p.28 "NIC FAX Initial Settings".

You need to register this machine by I/O device settings for ScanRouter V2 Lite/Professional.

Note

- The destinations programmed into Groups may be a mixture of destinations of users or groups registered to a ScanRouter V2 Lite server or ScanRouter V2 Professional server on the network and fax number destinations.

Note

- For information about registering a function to a user function key, see Chapter 6 "User Function Keys", *Advanced Features*.

- Enter the Group code which the destinations are programmed into.

Specifying by Groups (Quick Dial)

- Press the Quick Dial key which the Group destination is programmed into.

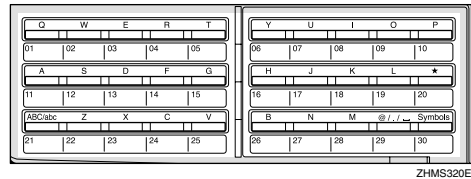

ZHMS320E

Specifying by Groups (Group Code)

- Press the user function key ([F1] to [F10]) assigned to the Groups function.

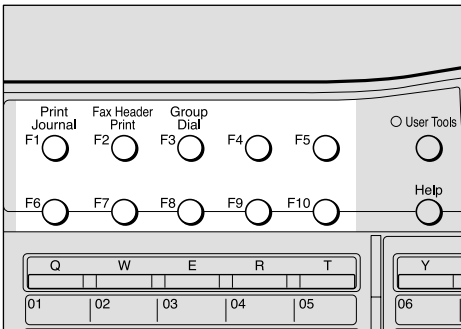

ZHMS170E

Specifying by Redial

- Press the [Pause/Redial] key.

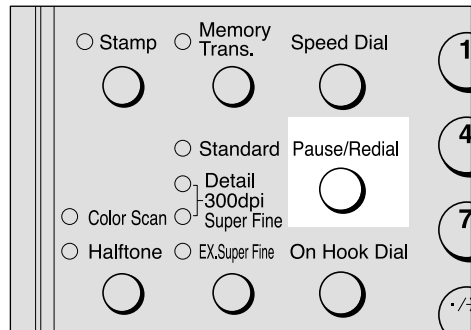

ZHMS310E

2 The last 10 destinations you dialed are shown. Press the **◀** or **▶** key to display the destination which you want to deliver the scanned data to.

3 Press the **[OK]** key.

Specifying Using the Number Keys

1 Press the user function key (**[F1]** to **[F10]**) assigned to the Scanner (Scan to E-mail) function.

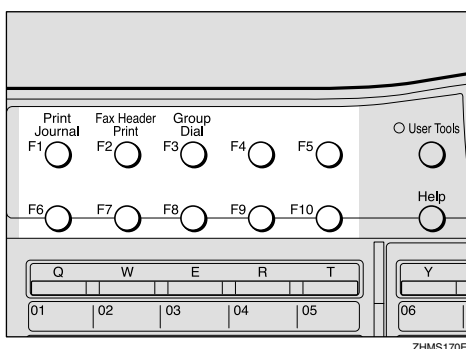

The display for entering the scanner destination appears.

Note

- The Scanner (Scan to E-mail) function is pre-assigned to the **[F10]** key.

2 Press the **[#]** key.



3 Enter the Short ID (three digits) for the user or group using the number keys.

For example, if the Short ID is "001," enter **[#][0][0][1]**.



4 Press the **[OK]** key.

The destination for ScanRouter V2 Lite/Professional that corresponds to the Short ID appears.

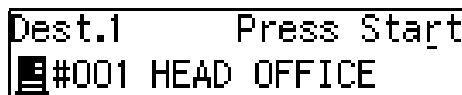

Note

- If you want to specify another destination, press the **[OK]** key and repeat steps **2** to **3**.
- See p.135 "Checking the Short ID of a Destination" for information about checking the Short ID of a destination.

Routing Received Fax Documents

Received fax documents can be automatically routed using ScanRouter V2 Professional.

To route using NIC FAX, follow p.122 "Setting up ScanRouter V2 Professional" and p.122 "Fax Document Delivery Settings".

Preparation

You need to make Network settings beforehand. See p.28 "NIC FAX Initial Settings".

You need to register this machine by I/O device settings for ScanRouter V2 Lite/Professional.

Setting up ScanRouter V2 Professional

The setup procedure for ScanRouter V2 Professional should be performed according to the instructions described in the "ScanRouter V2 Professional Setup Guide". However, the procedure described under "For a Device for Fax Delivery using RS232" in the Setup Guide is not necessary for this machine. This is because the machine transfers the received fax documents to ScanRouter V2 Professional server via a network.

Note

- To use ScanRouter V2 Professional, settings must be made by a customer engineer. Contact your nearest dealer.
- You may need to perform the procedure described under "For a Device for Fax Delivery using RS232" in the Setup Guide depending on the make of fax machine used with NIC FAX for sending and receiving fax documents with a ScanRouter V2 Professional server.

Fax Document Delivery Settings

To deliver fax documents, you need to make settings for transferring all received documents to the ScanRouter V2 Professional server using the NIC FAX Forwarding function. Follow the steps below to make the settings.

Note

- If the document delivery was not successful, NIC FAX prints out a Communication Failure Report as well as the document, and then clears the document data from memory.

Forwarding Received Documents to the ScanRouter V2 Professional Server

- 1** Press the **[User Tools]** key.

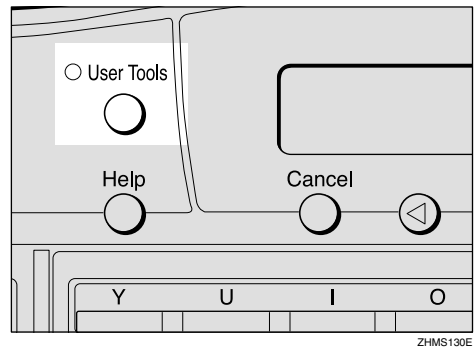

The User Tools main menu appears.

Note

- Start this procedure when the standby display is shown on the display. If the standby display is not shown, make it reappear. See Chapter 1 "Standby Display", *Basic Features*.

- 2** Press the ⏪ or ⏩ key to display "2. Fax Features".

```
User Tools:
2.Fax Features
```

- 3** Press the [OK] key.

- 4** Press the ⏪ or ⏩ key to display "4. Key Op. Tools".

```
Fax Features:
4.Key Op. Tools
```

- 5** Press the [OK] key.

- 6** Press [2] [2] [2] [2], and then press the [OK] key.

- 7** Press the ⏪ or ⏩ key to display "6. Forwarding".

```
Key Op. Tools:
6.Forwarding
```

 **Note**

- The number of the function differs depending on the options installed.

- 8** Press the [OK] key.

- 9** Confirm "1. On/Off" appears, and then press the [OK] key.

```
Forwarding:
On [Off]
```

- 10** Press the ⏪ or ⏩ key to select "On".

```
Forwarding:
[On] Off
```

- 11** Press the [OK] key.

 **Note**

- After you set the Forwarding to "On", make sure to follow the steps below to specify the destination.

- 12** Specify the destination.

When some destination is already registered:

Press the ⏪ or ⏩ key to display "2. Prog. Station", and then press the [OK] key.

```
Forwarding:
2.Prog. Station
```

When any destination is not registered:

Press the [OK] key.

```
Press OK to Program
Forwarding Station
```

- 13** Press the ⏪ or ⏩ key to display the number you want to register the destination in.

If the code "1" is available, select "1".

```
Program?
1:
```

- 14** Press the [OK] key.

- 15** Press the user function key (**[F1]** to **[F10]**) assigned to the Scanner (Scan to E-mail) function.

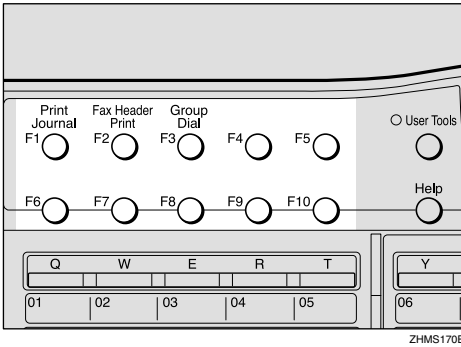

The Scanner display appears.

Note

- The Scanner (Scan to E-mail) function is pre-assigned to the **[F10]** key.

- 16** Enter **[#][0][0][0]**.



Note

- By specifying "#000" as the destination, all received fax documents are forwarded to the ScanRouter V2 Professional server, and delivered according to Fax Delivering ID or sender's information (Own Name (RTI) or Own Fax Number).

- 17** Press the **[OK]** key.

- 18** Press the **[User Tools]** key.

The standby display reappears.

Changing the Conditions for Forwarding Received Documents

With user parameters, you can change conditions for forwarding received documents to ScanRouter V2 Professional server. Normally, all received documents are forwarded to ScanRouter V2 Professional server, but you can filter forwarded documents using Fax Delivering ID. With this, NIC FAX prints only those received documents without a Fax Delivering ID. See p.166 "User Parameters" (switch 16, bit 5).

Note

- See p.126 "Transmission End Operation" for information about Fax Delivering ID.

Turning off Printing Functions of Received Fax Documents

When NIC FAX receives fax documents, it first prints, and then forwards to the ScanRouter V2 Professional server. If you want to forward documents without printing, turn off the printing function by following the procedure below.

Note

- If document delivery was not successful, NIC FAX prints out the Communication Failure Report as well as the document, and then clears the document data from memory.

- 1 Press the **[User Tools]** key.

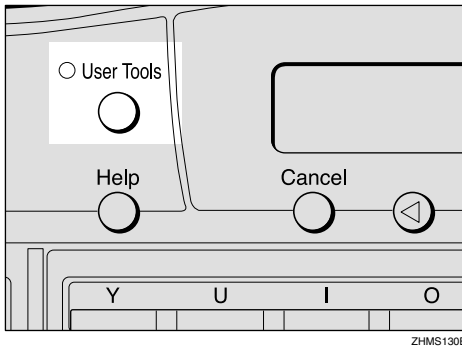

The User Tools main menu appears.

Note

- Start this procedure when the standby display is shown on the display. If the standby display is not shown, make it reappear. See Chapter 1 "Standby Display", *Basic Features*.

- 2 Press the **[Left Arrow]** or **[Right Arrow]** key to display "2. Fax Features".



- 3 Press the **[OK]** key.

- 4 Press the **[Left Arrow]** or **[Right Arrow]** key to display "4. Key Op. Tools".



- 5 Press the **[OK]** key.

- 6 Press **[2] [2] [2] [2]**, and then press the **[OK]** key.

- 7 Press the **[Left Arrow]** or **[Right Arrow]** key to display "10. User Parameters".

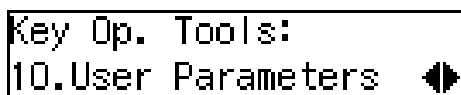

Note

- The number of the function differs depending on the options installed.

- 8 Press the **[OK]** key.

- 9 Confirm "1. Change" appears, and then press the **[OK]** key

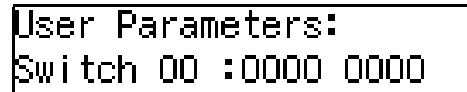

- 10 Press the **[Left Arrow]** or **[Right Arrow]** key to display switch 11.



- 11 Enter **[6]** using the number key to change the number displayed at bit 6 (second from the left) to 0.



- 12 Press the **[OK]** key.

- 13 Press the **[User Tools]** key.

The standby display reappears.

Transmission End Operation

There are two ways to select the destinations of fax document delivery through the ScanRouter V2 Professional server. Either specify destinations using Fax Delivering ID, or register the destinations that correspond to the sender's Own Name (RTI) or Own Fax Number. The choice of method depends on the functions available for the fax machine at the transmission end. Select the most appropriate method to suit your needs.

 **Note**

- You need to make settings for ScanRouter V2 Professional server, regardless of chosen method. See *ScanRouter V2 Professional Server Administrators' Guide* for more information.

❖ To Deliver Fax Documents Using Fax Delivering ID

You can use SUB code to specify the destination.

This method is available if SUB codes can be entered on the fax machine at the transmission end.

The transmitter enters the SUB code as the Fax Delivering ID to send documents.

 **Limitation**

- You cannot specify destinations using the Confidential Transmission (ID Override) function.
- If you cannot specify the end receiver, you cannot send the document using Fax Delivering ID. Send the document using Own Name (RTI) or Own Fax Number.

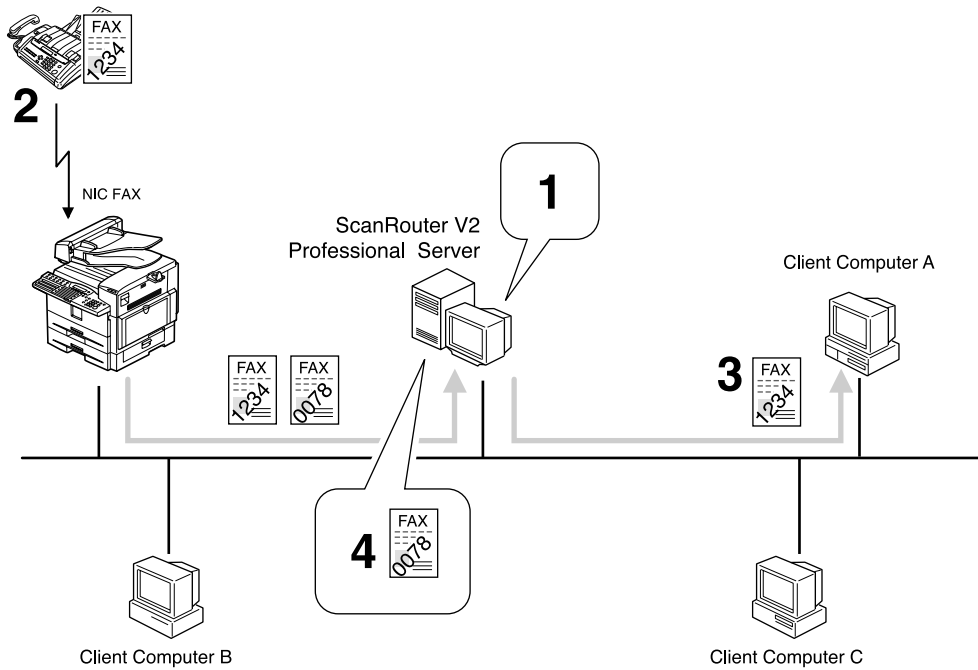

GFNTDS0E

- ① Register the Fax Delivering ID as a destination.
"1234: Client computer A"
- ② Specify the end receiver with the SUB code.
- ③ The fax document is delivered to the client computer with the specified Fax Delivering ID.
- ④ Fax documents with destinations that cannot be found are saved in the Undelivered Data In-Tray.

❖ **Delivering a Fax Document Using Own Name (RTI) or Own Fax Number**

Operation at the transmitting end is the same as that for conventional fax transmission.

The ScanRouter V2 Professional server determines the end receiver according to Own Name (RTI) or Own Fax Number registered to the fax machine at the transmitting end.

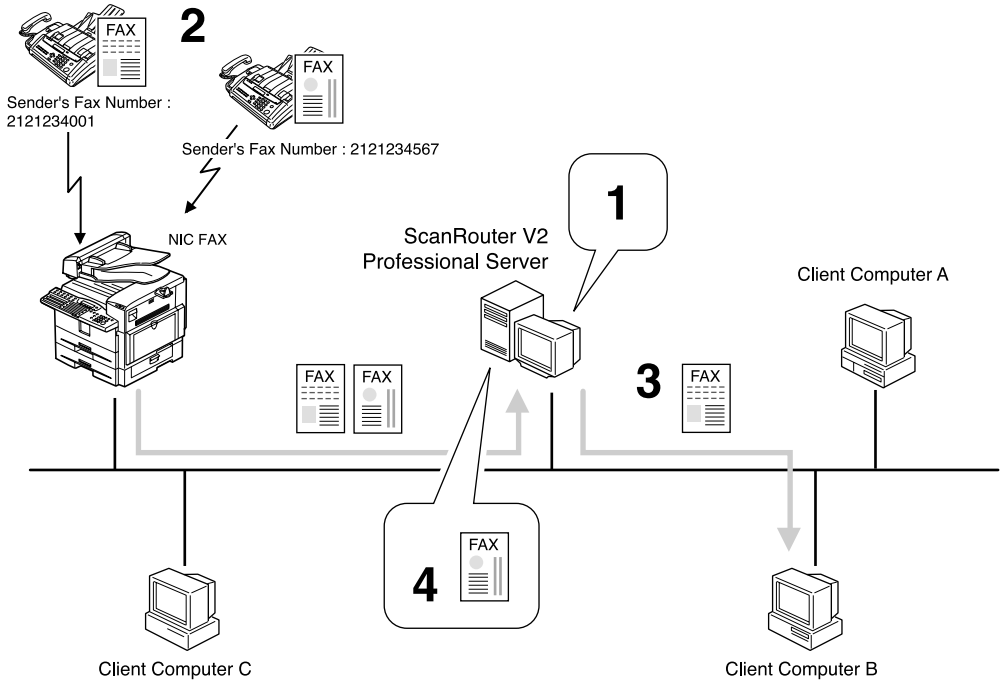

GFNTDS1E

Transmission Using the Backup File Transmission Feature

By using the Backup File Transmission function of NIC FAX, you can send and save backup files of sent fax documents in the ScanRouter V2 Professional server.

The documents sent to the ScanRouter V2 Professional server are delivered according to the destination settings for each receiving User or Group, so that they may be stored in the Inbox within the server or delivered to other computers by e-mail.

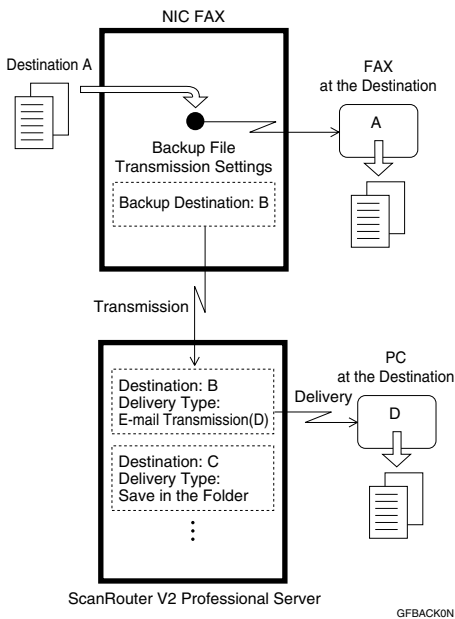

Reference

Chapter 3 "Backup File Transmission", *Advanced Features*

Chapter 7 "Backup File Transmission Settings", *Advanced Features*

Settings to Be Done on NIC FAX

To perform Backup File Transmission to the ScanRouter V2 Professional server, you need to make settings for the destinations of Backup File Transmission following the procedure described below. Once you make these settings, the Backup File Transmission is activated automatically whenever your NIC FAX performs fax transmissions.

1 Press the **[User Tools]** key.

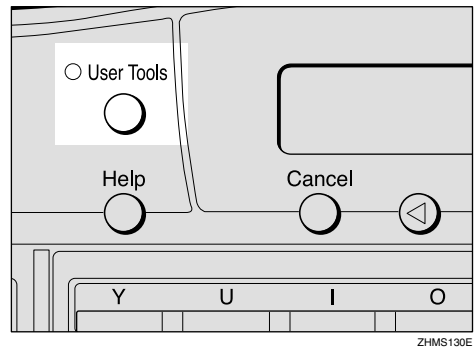

The User Tools main menu appears.

Note

Start this procedure when the standby display is shown on the display. If the standby display is not shown, make it reappear. See Chapter 1 "Standby Display", *Basic Features*.

2 Press the **[Left]** or **[Right]** key to display "2. Fax Features".



3 Press the **[OK]** key.

4 Press the **[Left]** or **[Right]** key to display "4. Key Op. Tools".



- 5 Press the [OK] key.
- 6 Press [2] [2] [2] [2], and then press the [OK] key.
- 7 Press the ⏪ or ⏩ key to display "7. Backup File TX (Backup File Transmission)".



Note

- The number of the function differs depending on the options installed.

- 8 Press the [OK] key.
- 9 Confirm "1. On/Off" appears, and then press the [OK] key



- 10 Press the ⏪ or ⏩ key to select "On".

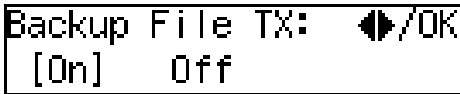

- 11 Press the [OK] key.

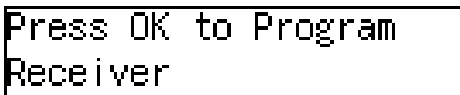

- 12 Press the [OK] key.

- 13 Press the user function key ([F1] to [F10]) assigned to the Scanner (Scan to E-mail) function.

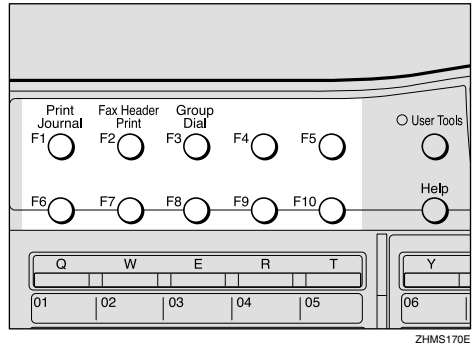

The Scanner display appears.

Note

- The Scanner (Scan to E-mail) function is pre-assigned to the [F10] key.

- 14 Press the [#] key.



- 15 Enter the Short ID (three digits) for the user or group for the destination of the backup file using the number keys.



Note

- See p.135 "Checking the Short ID of a Destination" for information about checking the Short ID of a destination.

- 16 Press the [OK] key.

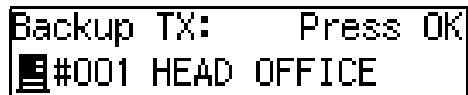

- 17 Press the [OK] key.

- 18** Enter the name of the receiver.

```
Name: [ABC]      Press OK
[HEAD OFFICE■■■■■■■■■■]
```

- 19** Press the [OK] key.

- 20** Press the [User Tools] key.

The standby display reappears.

Temporarily Terminating Fax Document Delivery

Temporarily terminate delivery of received fax documents by setting Memory Transmission to "Off", using the procedure below. Set to "On" when you want to resume delivery.

- 1** Press the [User Tools] key.

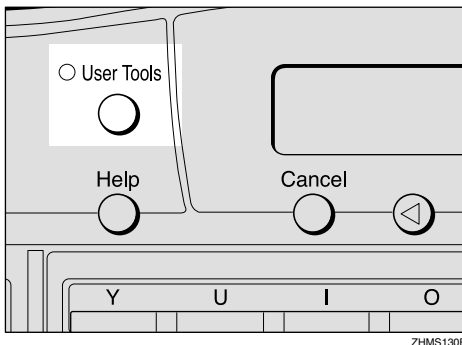

The User Tools main menu appears.

Note

- Start this procedure when the standby display appears. If the standby display appears. See Chapter 1 "Standby Display", *Basic Features*.

- 2** Press the ⏪ or ⏩ key to display "2. Fax Features".

```
User Tools:
2.Fax Features
```

- 3** Press the [OK] key.

- 4** Press the ⏪ or ⏩ key to display "4. Key Op. Tools".

```
Fax Features:
4.Key Op. Tools
```

- 5** Press the [OK] key.

- 6** Press [2] [2] [2] [2], and then press the [OK] key.

- 7** Press the ⏪ or ⏩ key to display "6. Forwarding".

```
Key Op. Tools:
6.Forwarding
```

Note

- The number of the function differs depending on the options installed.

- 8** Press the [OK] key.

- 9** Confirm "1. On/Off" appears, and then press the [OK] key

```
Forwarding:
On [Off]
```

- 10** Confirm "Off" is selected, and then press the [OK] key.

- 11** Press the [User Tools] key.

The standby display reappears.

8. Registering Addresses

Registering Addresses for Scanner

This section describes how to register e-mail address for the Scan to E-mail function or destinations on the network server for the Network Delivery Scanner function.

It is recommended that you register e-mail addresses or delivery destinations as Quick Dial or Speed Dial destinations for easy operation.

Registering/Editing a Destination

The procedure for storing an e-mail address for Scanner function or destination in a Quick Dial key or Speed Dial is basically the same as that for registering a fax number as Quick Dial or Speed Dial destination. The only difference is the way you enter a destination.

The following example describes how to register a destination as a Quick Dial destination.

Preparation

You need to assign the Scanner (Scan to E-mail) function to a user function key beforehand. If you fail to do so, you cannot enter the necessary data when registering a destination. See p.25 "Assigning User Function Keys".

The Scanner (Scan to E-mail) function is pre-assigned to the **[F10]** key.

You can register the following information in Quick Dial keys:

- Receiver's e-mail address or network server destination, and their names

Important

- It is recommended that you make a backup copy of the stored data after you register or edit it. The backup operation can be done through your Web browser. For detailed instructions, see the Web browser's online Help, or see p.153 "Making Settings through a Web Browser".

Note

- You can also make settings using the Web browser. See p.153 "Making Settings through a Web Browser".

1 Press the **[User Tools]** key.

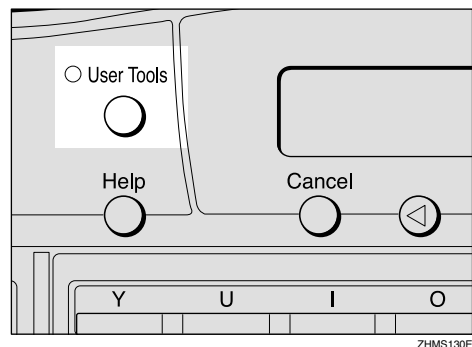

Note

- Start this procedure when the standby display is shown on the display. If the standby display is not shown, make it reappear. See Chapter 1 "Standby Display", *Basic Features*.

2 Press the **[Left Arrow]** or **[Right Arrow]** key to display "2. Fax Features".



3 Press the **[OK]** key.

- 4** Confirm "1. Program / Delete" appears, and then press the **[OK]** key



- 5** Confirm "1. Prog. Quick Dial" appears, and then press the **[OK]** key.

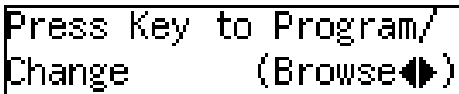

- 6** Press the Quick Dial key you want to program a new destination into, or the destination you want to edit is programmed into.

Press the Quick Dial key, or press the **[Left]** or **[Right]** key to select the destination, and then press the **[OK]** key.



Note

- If an e-mail address is already assigned to the selected Quick Dial key, the assigned e-mail address appears. To edit the e-mail address, press the **[Clear/Stop]** key to delete the e-mail address shown on the display, and then enter the new e-mail address.
- You cannot assign an address to a Quick Dial key which another function is already programmed into.

- 7** Press the user function key (**[F1]** to **[F10]**) assigned to the Scanner (Scan to E-mail) function.

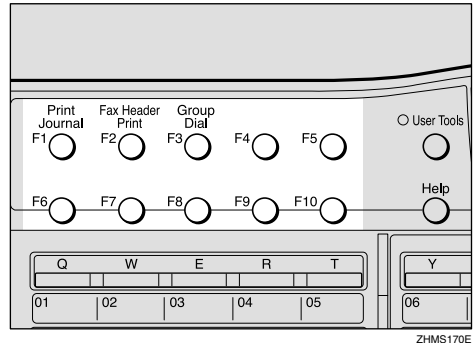

Note

- The Scanner (Scan to E-mail) function is pre-assigned to the **[F10]** key.

- 8** Enter the e-mail address or the destination on the network server.

To Specify the E-mail Address

- 1** Enter the e-mail address.



Note

- You can enter up to 127 characters for an e-mail address.
- You can enter "." and "@" using a Quick Dial key. Press the **[Symbols]** key to enter symbols. You can shift between upper and lower case by pressing the **[ABC/abc]** key.
- To enter texts registered in "Template: Address", press the **[Star]** key, press the **[Left]** or **[Right]** key to display the desired text, and then press the **[OK]** key. See p.147 "Registering Template Addresses".

- If you incorrectly enter characters, press the **[Clear/Stop]** key, and then enter the correct characters.

2 Press the **[OK]** key

```

001          Press OK
[nicf2@def.company.co]
  
```

To Specify the Destination on the Network Server

1 Press the **[#]** key.

```

Scanner: [abc] Press OK
#[          ]
  
```

- 2** Enter the Short ID (3-digit number) for the user or group of the destination.

```

Scanner: [abc] Press OK
#001[          ]
  
```

Note

- See p.135 "Checking the Short ID of a Destination" for information about checking the Short ID of a destination.

3 Press the **[OK]** key.

```

001          Press OK
[#001 HEAD OFFICE]
  
```

Note

- When you enter Short ID (3-digit number) for a user or group, the corresponding destination registered to ScanRouter V2 Lite/Professional appears on the display.

9 Press the **[OK]** key.

```

001 [ABC]          Name
[          ]
  
```

10 Enter the name of the receiver.

```

001 [ABC]          /OK
[NEW YORK BRANCH[          ]
  
```

Note

- To edit the currently registered name, press the **[Clear/Stop]** key deleting the name displayed on the display, and then enter the new name.

11 Press the **[OK]** key.

The destination for scanner is registered.

12 Press the **[User Tools]** key.

The standby display reappears.

Checking the Short ID of a Destination

Follow the procedure below to check the Short ID of a destination registered to a ScanRouter V2 Lite server or ScanRouter V2 Professional server.

1 Start up the ScanRouter V2 Administration Utility.

2 Select the server on the Select Server display.

This display appears when the program is started up for the first time.

- Enter the Administrator Password, and then click [OK].

Using ScanRouter V2 Lite

- Click [Destination] under [Delivery Table]. The list of users and groups is displayed. Check the Short ID of the desired address.

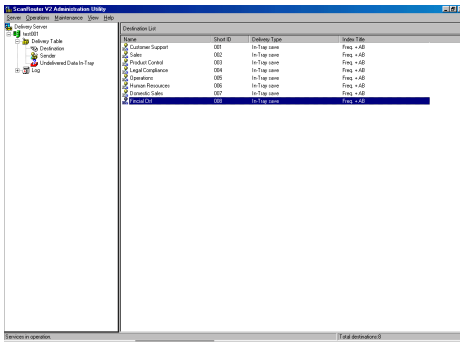

Using ScanRouter V2 Professional

- Click [Destination List] under [Delivery Table].
- Click [Standard Destination List] under [Destination List]. The list of users and groups appears. Check the Short ID of the desired address.

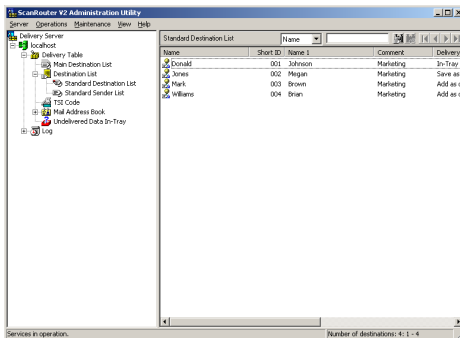

Registering Addresses for Internet Faxing

This section describes how to register an e-mail address used as a destination for Internet Faxing.

You can easily specify a destination by registering the e-mail address of the receiving party as a Quick Dial or Speed Dial destination. If you turn on the Label Insertion function, the registered name is automatically printed on the first page of the sent message with "To" before it.

You can also attach a document to the fax message with an easy operation if you store an Auto Document in the Quick Dial key which the destination is registered to.

Reference

Chapter 3 "Label Insertion", *Advanced Features*

Chapter 6 "Auto Documents", *Advanced Features*

Registering/Editing a Destination

The procedure for registering a destination for Internet Faxing with Quick Dial or Speed Dial is basically the same as that for registering a fax number as a Quick Dial or Speed Dial destination. The only difference is that you enter an e-mail address instead of a fax number.

The following example describes how to register a destination as a Quick Dial destination.

Preparation

You need to assign the Internet FAX function to a user function key beforehand. If you fail to do so, you cannot enter the e-mail address when registering a destination. See p.25 "Assigning User Function Keys".

The Internet FAX function is pre-assigned to the **[F5]** key.

You can program the following items for a Quick Dial destination:

- E-mail address and name of the receiving party
- On/off for the Label Insertion function
- Selection of Fax Header

Important

- It is recommended that you make a backup copy of the stored data after you register or edit it. The backup operation can be done through your Web browser. For detailed instructions, see the Web browser's online Help and p.153 "Making Settings through a Web Browser".

Note

- You can store an e-mail address as a Speed Dial destination or Group destination in the same way as a Quick Dial destination.
- You can also make settings using your Web browser. See p.153 "Making Settings through a Web Browser".

1 Press the **[User Tools]** key.

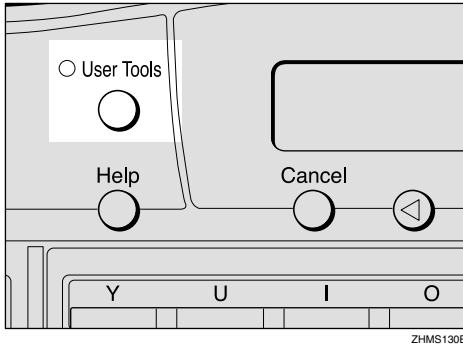

Note

- Start this procedure when the standby display is shown on the display. If the standby display is not shown, make it reappear. See Chapter 1 "Standby Display", *Basic Features*.

2 Press the **[Left Arrow]** or **[Right Arrow]** key to display "2. Fax Features".



3 Press the **[OK]** key.

4 Confirm "1. Program / Delete" appears, and then press the **[OK]** key.



5 Confirm "1. Prog. Quick Dial" appears, and then press the **[OK]** key.

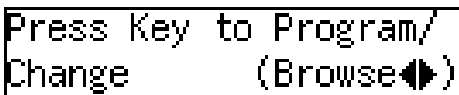

6 Press the **Quick Dial** key you want to program a new destination into, or the key whose destination you want to edit is programmed into.

Press the **Quick Dial** key, or press **[Left Arrow]** or the **[Right Arrow]** key to select the destination, and then press the **[OK]** key.



Note

- If an e-mail address is already registered to the selected Quick Dial key, the currently registered e-mail address appears. To edit the address, press the **[Clear/Stop]** key to delete the e-mail address shown on the display, and then enter the new e-mail address.
- You cannot register an e-mail address to a Quick Dial key that another function is already registered to.

7 Press the user function key (**[F1]** to **[F10]**) assigned to the Internet FAX function.

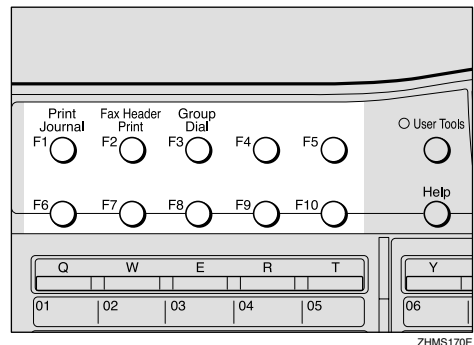

The display for entering an address appears.

Note

- The Internet FAX function is pre-assigned to the **[F5]** key.

If the Network Transmission Auto Check Function Is Turned Off

If the Network Transmission Auto Check function is set to "Off" with user parameters, select "Mail Address" in the display that appears. For information about changing this setting, see p.166 "User Parameters" (switch 32, bit 1).

- ❶ Confirm "1. Mail Address" appears, and then press the **[OK]** key.



- ❷ Enter the e-mail address you want to register.

When the Network Transmission Auto Check Function set to On:



When the Network Transmission Auto Check Function set to Off:



Note

- ❑ You can enter up to 127 characters for an e-mail address.
- ❑ You can enter "." and "@" using a Quick Dial key. Press the **[Symbols]** key to enter symbols. You can shift between upper and lower case by pressing the **[ABC/abc]** key.
- ❑ To enter texts registered in "Template: Address", press the **[★]** key, press the **[Left]** or **[Right]** key to display the desired text, and then press the **[OK]** key. See p.147 "Registering Template Addresses".

- ❑ If you incorrectly enter characters, press the **[Clear/Stop]** key, and then enter the correct characters.

- ❸ Press the **[OK]** key.



- ❹ Press the **[OK]** key.

- ❺ Enter the name of the receiver.



Note

- ❑ To edit the currently registered name, press the **[Clear/Stop]** key to delete the name shown, and then enter the new name.

- ❻ Press the **[OK]** key.

- ❼ Press the **[Left]** or **[Right]** key to select "On" or "Off".

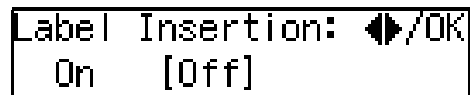

Note

- ❑ If you set the Label Insertion function to "On", documents are transmitted by Sequential Broadcasting.

Reference

p.79 "When using NIC FAX with Broadcasting and Sequential Broadcasting"

Chapter 3 "Label Insertion", *Advanced Features*

- ❽ Press the **[OK]** key.

- 15 Press the ⏪ or ⏩ key to select "Hdr.1 (Fax Header 1)" or "Hdr.2 (Fax Header 2)".



- 16 Press the [OK] key.
The e-mail address is registered.

 **Note**

- To register another Quick Dial destination, repeat the procedure from step 5.

- 17 Press the [User Tools] key.
The standby display reappears.

 **Transmission Using a Quick Dial Destination**

Follow these steps to send a fax document to a Quick Dial destination:

- ① Make sure that the **Memory Trans.** indicator is lit.
- ② Set the original, and then make necessary adjustments to scan the settings.
- ③ Press the Quick Dial key that the receiver is programmed into.
The name or e-mail address of the destination appears.
- ④ After confirming the destination, press the **[Start]** key.

Registering Addresses for IP-Faxing

This section describes how to register an IP address, host name, or alias fax number used as a destination for IP-Faxing.

You can easily specify a destination by registering the IP address of the receiving party with Quick Dial or Speed Dial. If you turn on the Label Insertion function, the registered name is automatically printed on the first page of the sent message with "To" before it.

You can also attach a document to the fax message with an easy operation if you store an Auto Document in the Quick Dial key the destination is registered to.

Reference

Chapter 3 "Label Insertion", *Advanced Features*

Chapter 6 "Auto Documents", *Advanced Features*

Registering/Editing a Destination

The procedure for registering a destination for IP-Faxing as a Quick Dial or Speed Dial destination is basically the same as that for registering a fax number as a Quick Dial or Speed Dial destination. The only difference is the way you enter a destination.

The following example describes how to register a destination as a Quick Dial destination.

Preparation

You need to assign the Internet FAX function to a user function key beforehand. If you fail to do so, you cannot enter the necessary data when registering a destination. See p.25 "Assigning User Function Keys".

The Internet FAX function is pre-assigned to the **[F5]** key.

You can program the following items as Quick Dial destinations:

- IP address (or the host name or alias fax number) and name of the receiving party
- On/off for the Label Insertion function
- Selection of Fax Header

Important

- It is recommended that you make a backup copy of the stored data after you register or edit it. The backup operation can be done through your Web browser. For detailed instructions, see the Web browser's online Help and p.153 "Making Settings through a Web Browser".

Note

- Do not register both alias fax number and IP address or alias fax number and host name for the same destination.
- You can store an IP-Fax number as a Speed Dial destination or Group destination in the same way as storing it as a Quick Dial destination.
- You can also make settings through the Web browser. See p.153 "Making Settings through a Web Browser".

1 Press the **[User Tools]** key.

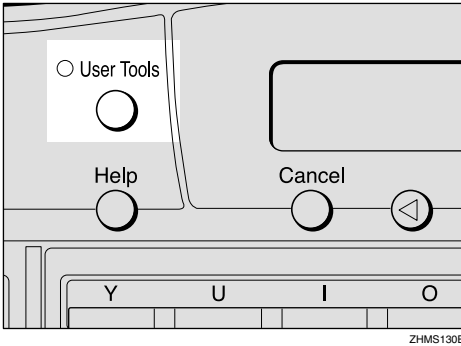

Note

- Start this procedure when the standby display is shown on the display. If the standby display is not shown, make it reappear. See Chapter 1 "Standby Display", *Basic Features*.

2 Press the **[Left Arrow]** or **[Right Arrow]** key to display "2. Fax Features".



3 Press the **[OK]** key.

4 Confirm "1. Program / Delete" appears, and then press the **[OK]** key.



5 Confirm "1. Prog. Quick Dial" appears, and then press the **[OK]** key.

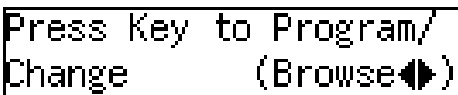

6 Press the **Quick Dial** key you want to program a new destination into, or the destination you want to edit is programmed into.

Press the **Quick Dial** key, or press the **[Left Arrow]** or **[Right Arrow]** key to select the destination, and then press the **[OK]** key.



Note

- If an IP address is already assigned to the selected **Quick Dial** key, the assigned IP address appears. To edit the IP address, press the **[Clear/Stop]** key to delete the IP address shown on the display, and then enter the new IP address.
- You cannot assign an address to a **Quick Dial** key which another function is already programmed into.

7 Press the user function key (**[F1]** to **[F10]**) assigned to the **Internet FAX** function.

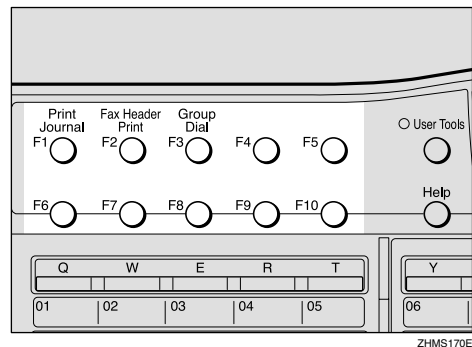

The display for entering an address appears.

Note

- The **Internet FAX** function is pre-assigned to the **[F5]** key.

If the Network Transmission Auto Check Function Is Turned Off

If the Network Transmission Auto Check function is set to "Off" with user parameters, select IP-Fax Transmission in the display that appears. For information about changing this setting, see p.166 "User Parameters" (switch 32, bit 1).

- ① Press the ⏪ or ⏩ key to select "2. IP-Fax Address".

```
Address
2. IP-Fax Address
```

- ② Press the [OK] key.

- 8 Enter the destination for IP-Faxing you want to register.

Using IP Address or Host Name

- ① Enter the IP address or host name you want to register.

If the Network Transmission Auto Check function is set to "On":

```
Address: [abc] /OK
192.168.1.10
```

If the Network Transmission Auto Check function is set to "On":

```
IP-Fax: [abc] Press OK
192.168.1.10
```

Note

- IP addresses and host names can contain up to 127 characters.

- When specifying a destination using IP address, you may need to give the port number too, depending on network settings at the receiving end. For example, if the destination IP address is 192.168.1.100 and the port number is 2100, you should identify the destination as 192.168.1.100:2100. Contact your network administrator for details.

- When specifying a destination using host name, you may need to give the port number too, depending on network settings at the receiving end. For example, if the destination host name is "abc.company.com" and the port number is 2100, you should identify the destination as "abc.company.com:2100". Contact your network administrator for details.

- When specifying a destination using host name, set the DNS Server Address beforehand.

- ② Press the [OK] key.

- ③ Press the ⏪ or ⏩ key to select "2. IP-Fax Address".

```
Network TX Option
2. IP-Fax Address
```

Note

- If the Network Transmission Auto Check function is turned off, the display does not appear. Proceed to step 9. See p.166 "User Parameters" (switch 32, bit 1).

- 4 Press the [OK] key.



Using an Alias Fax Number without VoIP Gateway

To use an alias fax number, you need to select "Yes" with user parameters for gatekeeper IP-Fax transmission. See p.166 "User Parameters" (switch 32, bit 0). You also need to register the gatekeeper address and alias fax number with IP-Fax Parameter settings. See p.43 "IP-Fax Parameter Settings".

- 1 Enter the alias fax number using the number keys.

When the Network Transmission Auto Check function is set to "On":



When the Network Transmission Auto Check function is set to "Off":



- 2 Press the [OK] key.
- 3 Press the ⏪ or ⏩ key to select "2. IP-Fax Address".



Note

- If the Network Transmission Auto Check function is turned off, the display does not appear. Proceed to step 5. See p.166 "User Parameters" (switch 32, bit 1).

- 4 Press the [OK] key.



- 5 Press the ⏪ or ⏩ key to select "No".



- 6 Press the [OK] key.



Using VoIP Gateway

If you use the VoIP gateway, documents are transmitted to a G3 fax machine connected to public telephone line via the VoIP gateway.

- 1 Enter the G3 fax number of the receiver using the number keys.



Note

- To use the gatekeeper, you need to select "Yes" with user parameters for gatekeeper IP-Fax transmission. See p.166 "User Parameters" (switch 32, bit 0).
- You also need to register the gatekeeper address and alias fax number with IP-Fax Parameter settings. See p.43 "IP-Fax Parameter Settings".

- 2 Press the [OK] key.
- 3 Press the ⏪ or ⏩ key to select "2. IP-Fax Address".



 **Note**

- If the Network Transmission Auto Check function is turned off, the display does not appear. Proceed to step 5. See p.166 "User Parameters" (switch 32, bit 1).

4 Press the **[OK]** key.



5 Confirm "Yes" is selected, and then press the **[OK]** key.

The display for entering the VoIP gateway address appears.

6 Enter the IP address or host name of the VoIP gateway.



 **Note**

- If you use the gatekeeper, the following display appears. Enter the alias fax number registered on the gatekeeper.



 **Reference**

p.44 "Own Fax Number (Alias Fax Number)"

7 Press the **[OK]** key.



9 Press the **[OK]** key.



10 Enter the name of the receiver.

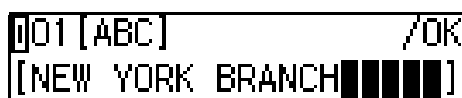

 **Note**

- To edit the currently registered name, press the **[Clear/Stop]** key to delete the name shown, and then enter the new name.

 **Reference**

Chapter 3 "Entering Characters", *Basic Features*

11 Press the **[OK]** key.

12 Press the **[Left]** or **[Right]** key to select "On" or "Off".

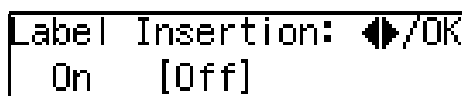

 **Reference**

Chapter 3 "Label Insertion", *Advanced Features*

13 Press the **[OK]** key.

14 Press the **[Left]** or **[Right]** key to select "Hdr.1 (Fax Header 1)" or "Hdr.2 (Fax Header 2)".



15 Press the **[OK]** key.

The destination is registered.

 **Note**

- To register another Quick Dial destination, repeat the procedure from step 5.

16 Press the **[User Tools]** key.

The standby display reappears.

 **Transmission Using a Quick
Dial Destination**

Follow these steps to send IP-Fax using Quick Dial keys:

- ① Set the original, and then make necessary adjustments to scan the settings.
 - ② Press the Quick Dial key the destination is programmed into.
The name, IP address, host name, or alias fax number of the destination appears.
 - ③ After confirming the destination, press the **【Start】** key.
- 

Registering Template Addresses

This section describes how to register frequently-used texts to enter e-mail addresses.

You can easily extract a text by pressing the **[★]** key when you enter e-mail address.

Limitation

- ❑ You can use registered texts to specify destinations for Scanner, Internet Fax, and IP-Fax functions, but not to enter IP addresses or domain names for the Network settings.

Note

- ❑ You can register up to 20 texts.
- ❑ You can use up to 16 characters when registering texts.

Reference

p.61 "Using Scan to E-mail Functions"

p.74 "Transmitting Internet Fax"

p.100 "Transmitting IP-Fax"

- 1** Press the **[User Tools]** key.

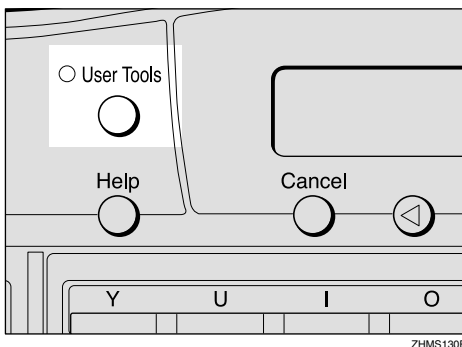

The User Tools main menu appears.

Note

- ❑ Start this procedure when the standby display is shown. If the standby display is not shown, make it reappear. See Chapter 1 "Standby Display", *Basic Features*.

- 2** Press the **[⏪]** or **[⏩]** key to display "2. Fax Features".



- 3** Press the **[OK]** key.

- 4** Confirm "1. Program / Delete" appears, and then press the **[OK]** key.



- 5** Press the **[⏪]** or **[⏩]** key to display "11. Prog. Addr. Temp.".



- 6** Press the **[OK]** key.

- 7** Press the **[⏪]** or **[⏩]** key to display the text number you want to program or edit.



- 8** Press the **[OK]** key.

- 9** Enter the text you want to register.



- 10** Press the **[OK]** key.
The text is registered.

- 11** Press the **[User Tools]** key.
The standby display reappears.

Deleting Template Addresses

- 1** Press the **[User Tools]** key.

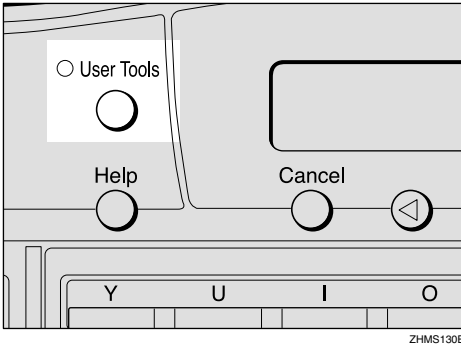

The User Tools main menu appears.

Note

- Start this procedure when the standby display is shown on the display. If the standby display is not shown, make it reappear. See Chapter 1 "Standby Display", *Basic Features*.

- 2** Press the **[Left]** or **[Right]** key to display "2. Fax Features".



- 3** Press the **[OK]** key.

- 4** Confirm "1. Program / Delete" appears, and then press the **[OK]** key.



- 5** Press the **[Left]** or **[Right]** key to display "12. Del. Addr. Temp.".



- 6** Press the **[OK]** key.

- 7** Press the **[Left]** or **[Right]** key to display the text you want to delete.



- 8** Press the **[OK]** key.

- 9** Press the **[Left]** or **[Right]** key to select "Yes".

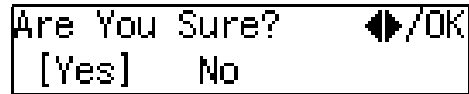

Note

- To cancel the delete, select "No".

- 10** Press the **[OK]** key.

The text is deleted.

- 11** Press the **[User Tools]** key.
The standby display reappears.

Registering Template Subjects and Messages

This section describes how to register template subjects and messages to use on the Subject/Message display under "Mail Options". You can easily extract registered subjects and messages with the **[★]** key, when setting a subject and/or message on the Subject/Message display.

Preparation

To register messages, you need to assign the E-mail Message function to a user function key beforehand. See p.25 "Assigning User Function Keys".

Note

- You can register up to five subjects and/or messages.
- When registering only a subject, you can enter up to 150 characters.
- When registering only message or both a subject and message, you can enter up to 148 characters, since the space of two characters is used when the E-mail Message function key is pressed.
- If you send e-mail without setting a subject/message in "Mail Options" when a subject/message is already registered as No.1 on the Template: Subject display, the registered subject/message is automatically used.
- You can check the registered subjects and messages in User Parameter List. See Chapter 7 "How to Set the User Parameters - Printing the User Parameter List", *Advanced Features*.

Reference

p.61 "Using Scan to E-mail Functions"

p.74 "Transmitting Internet Fax"

1 Press the **[User Tools]** key.

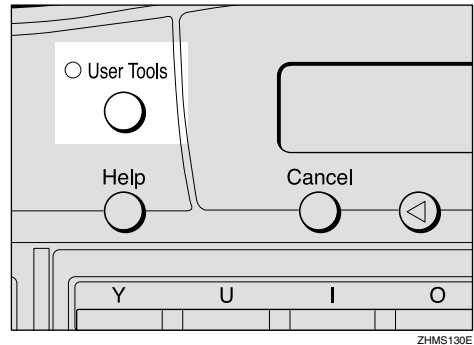

The User Tools main menu appears.

Note

- Start this procedure when the standby display is shown on the display. If the standby display is not shown, make it reappear. See Chapter 1 "Standby Display", *Basic Features*.

2 Press the **⏪** or **⏩** key to display "2. Fax Features".



3 Press the **[OK]** key.

4 Press the **⏪** or **⏩** key to display "4. Key Op. Tools".



5 Press the **[OK]** key.

6 Press **[2] [2] [2] [2]**, and then press the **[OK]** key.

7 Press the \leftarrow or \rightarrow key to display "15. Network".



Note

- The number of the function differs depending on the options installed.

8 Press the **[OK]** key.

9 Press the \leftarrow or \rightarrow key to display "2. Mail Server".



10 Press the **[OK]** key.

11 Press the \leftarrow or \rightarrow to display "13. Template: Subject".



Note

- The number of the function differs depending on the settings of the machine.

12 Press the **[OK]** key.

13 Enter the number of the subject or message you want to program or edit using the number keys.

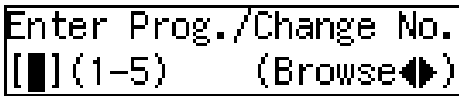

Note

- If you are selecting a number that is not registered, proceed to step 14.
- To browse, press the \leftarrow or \rightarrow key.

14 Press the **[OK]** key.

15 Enter a subject.



Note

- If you do not want to enter a subject, proceed to step 16.
- If a subject/message is already registered to the selected number, the currently registered subject/message appears. To edit the subject/message, press the **[Clear/Stop]** key, deleting, and then enter a new subject/message.

Reference

Chapter 3 'Entering Characters', *Basic Features*

16 To enter a message, press the user function key (**[F1]** to **[F10]**) assigned to the E-mail Message function.

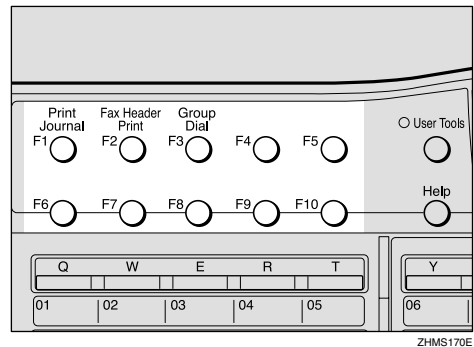

Note

- If you do not want to enter a message, proceed to step 17.

17 Enter a message.



- 18 Press the **[OK]** key.
The subject/message is registered.

- 19 Press the **[OK]** key.

```
Used When There is No
Subject.          Press OK
```

Note

- This display appears when the subject/message is programmed as No.1. If you register the subject/message as No.2 or higher, proceed to step 20.

- 20 Press the **[User Tools]** key.
The standby display reappears.

Deleting Template Subjects and Messages

- 1 Press the **[User Tools]** key.

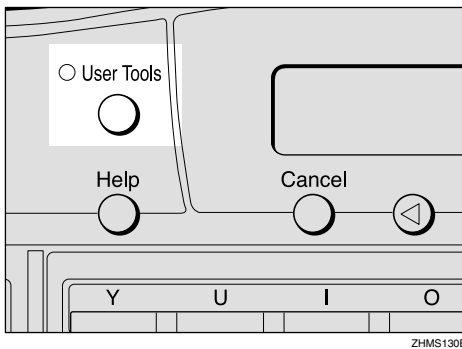

The User Tools main menu appears.

Note

- Start this procedure when the standby display appears. If the standby display is not shown, make it reappear. See Chapter 1 "Standby Display", *Basic Features*.

- 2 Press the **[◀]** or **[▶]** key to display "2. Fax Features".

```
User Tools:
2.Fax Features
```

- 3 Press the **[OK]** key.

- 4 Press the **[◀]** or **[▶]** key to display "4 Key Op. Tools".

```
Fax Features:
4.Key Op. Tools
```

- 5 Press the **[OK]** key.

- 6 Press **[2] [2] [2] [2]**, and then press the **[OK]** key.

- 7 Press **[◀]** or **[▶]** to display "15. Network".

```
Key Op. Tools:
15.Network
```

Note

- The number of the function differs depending on the options installed.

- 8 Press the **[OK]** key.

- 9 Press the **[◀]** or **[▶]** key to display "2. Mail Server".

```
Network:
2.Mail Server
```

- 10 Press the **[OK]** key.

- 11 Press the **[◀]** or **[▶]** key to display "13. Template: Subject".

```
Mail Server:
13.Template: Subject
```

 **Note**

- The number of the function differs depending on the settings of the machine.

12 Press the **[OK]** key.



13 Enter the number of the subject or message you want to delete using the number keys.



 **Note**

- To browse, press the ◀ or ▶ key.

14 Press the **[OK]** key.



15 Press the **[Clear/Stop]** key.

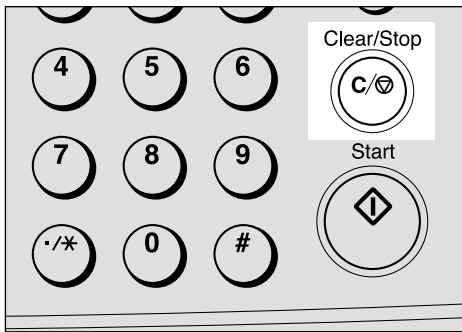

ZHMS070E



16 Press the **[OK]** key.
The subject/message is deleted.

17 Press the **[User Tools]** key.
The standby display reappears.

9. Making Settings through a Web Browser

Connecting from your Computer

Using a Web browser in your computer connected to a network, you can check the status of fax communications, as well as make changes to the settings.

System Requirements

❖ Operating Systems

Microsoft Windows 95/98/Me
Microsoft Windows NT4.0
Microsoft Windows 2000
Microsoft Windows XP

❖ Web Browser Applications That Have Been Confirmed to Work

Microsoft Internet Explorer 6.0
Netscape Communicator 4.78
Netscape 6.2

⚠ Limitation

- The monitor resolution must be SVGA (800 × 600) or higher.
- You may not be able to return to the previous page by clicking the **[Back]** button on the Web browser. Use the on-screen Menu button in order to switch the display.

Note

- Different language versions of Web browser applications may have different version numbers.

Initial Display

The initial display appears when you start up the Web browser and enter your fax machine's IP address or host name as a URL.

❖ Entering the URL

- Example: If the IP address of your fax machine is "192.168.1.10", enter "http://192.168.1.10/".
- Example: If the host name of your fax machine is "fax1", enter "http://fax1/".

Note

- In the following cases, you can use the host name as the URL:
 - When the DNS server is connected to the network:
Register the NIC FAX IP address and host name on the DNS server.
 - When the WINS server is connected to the network:
Register the WINS server address and host name on NIC FAX.
- For details, consult your network administrator.
- If you use the Network Boot function, the NIC FAX IP address may change. Pay attention to this. If you use dynamic DNS, specify the host name. See p.32 "Network Boot".
- Proxy servers are not recommended. If multiple users connect to NIC FAX via a proxy server, they can enter Administrator Mode simultaneously.
- If you have to use a proxy server, use the Web browser to make the following settings:
 - Using Internet Explorer
Go to **[Tools]**, **[Internet Options]**, **[Connections]**, **[LAN Settings]**, and **[Advanced]** in this order. In the **[Do not use Proxy server for addresses beginning with:]** text box, enter your NIC FAX IP address.
 - Using Netscape Communicator
Go to **[Edit]**, **[Preferences]**, **[Advanced]**, **[Proxies]**, and **[View]** in this order. In the **[Do not use Proxy servers for Domain Names beginning with:]** text box, enter your NIC FAX IP address.

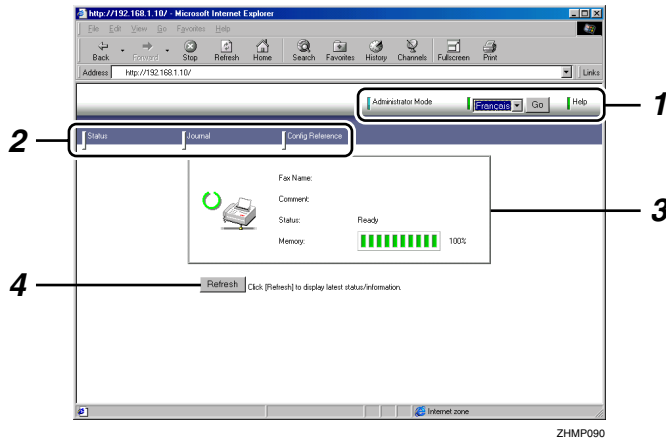

1. Header Area

❖ [Administrator Mode]

Click this button to enter the Administrator Mode where you can make changes to the settings of your NIC FAX. When you enter this mode, a dialog box appears, asking you to enter your user name and password. Enter only the password in this dialog box. **[Exit Administrator Mode]** appears when Administrator Mode is active. Click the button to exit.

❖ Language Menu, [Go]

Select **[English]**, **[Français]**, **[Español]**, **[Deutsch]**, **[Italiano]**, **[Svenska]**, **[Norsk]**, **[Português]**, or **[Nederlands]** from the Language menu and click **[Go]** to switch the language.

❖ [Help]

Click this button to display the Help. The URL for Help is specified in the Properties Settings in the Administrator Mode. See p.157 “Using Online Help”.

📝 Note

- ❑ When checking status or making settings with the buttons in the Menu area, **[Top Page]** appears, but the Language menu and the **[Go]** button are not displayed. Click **[Top Page]** to return to the initial display.

2. Menu Area

Click these buttons in the Menu area to check current status or make settings for your NIC FAX.

[Status], **[Journal]**, and **[Config Reference]** appear when Administrator Mode is inactive. **[Status]**, **[Journal]**, **[Configuration]**, and **[Maintenance]** appear when Administrator Mode is active.

3. Display Area

Fax Name, Comment, Status, and Memory are displayed in this area.

4. [Refresh] Button

If you click this button, the Web browser accesses your NIC FAX and reloads the latest data of the machine's condition.

Functions You Can Check or Set Up

You can check the status or change settings of the following items using the Web browser:

❖ **Items that You Can Monitor**

- Fax name
- Comment
- Status
- Memory level
- Paper tray
- Toner level
- Functions available when options are installed
- Memory usage (Transmission, Reception, Auto document)
- Journal (Transmission, Reception)
- Quick Dial destinations, Speed Dial destinations, Group Dial destinations
- Forwarding destinations, Forwarding options
- Boxes
- Setup (General, TCP/IP, E-Mail, IP-Fax, Backup Receiver, Others)

❖ **Settings that You Can Make in the Administrator Mode**

- Destinations for Quick Dial, Speed Dial, and Group Dial (Program, Change, or Delete)
- Destinations for Forwarding (Program, Change, Delete, or Change Forwarding Options)
- Boxes (Program, Change, or Delete)
- Setup (General, TCP/IP, E-Mail, IP-Fax, Backup Receiver, Others)
- Password
- Backup
- Restore

Using Online Help

Online Help is included as an HTML file on the CD-ROM that comes with NIC FAX. You need to specify the location of the Help file in the **[Setup]** setting under **[Configuration]** in order to use it.

After making necessary settings for using online Help, you can display the Help (which is in HTML format) by clicking **[Help]** (one of the buttons in the Header area).

◆ Location of the Help File

English	\\HELP\WSMHLP\en
Français	\\HELP\WSMHLP\fr
Español	\\HELP\WSMHLP\es
Deutsch	\\HELP\WSMHLP\de
Italiano	\\HELP\WSMHLP\it
Svenska	\\HELP\WSMHLP\sv
Norsk	\\HELP\WSMHLP\no
Português	\\HELP\WSMHLP\pt
Nederlands	\\HELP\WSMHLP\nl

Help files in each language are stored in the folder, listed above on the CD-ROM.

To use Help, copy it to your computer's hard disk. Be sure to copy all files in the folder to the new folder you have created on the hard disk.

1 Click **[Administrator Mode]**.

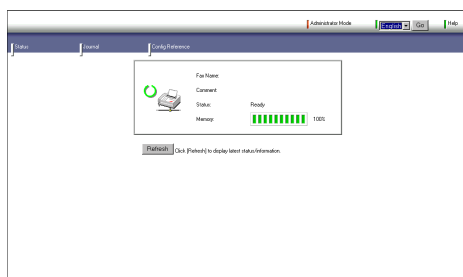

2 Enter the Administrator password, and then click **[OK]**.

You do not need to enter the user name.

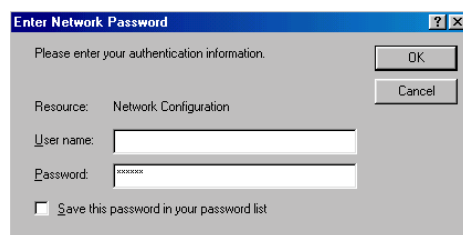

3 Click **[Configuration]**.

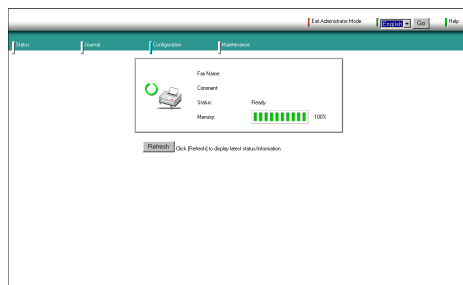

4 Click **[Setup]**.

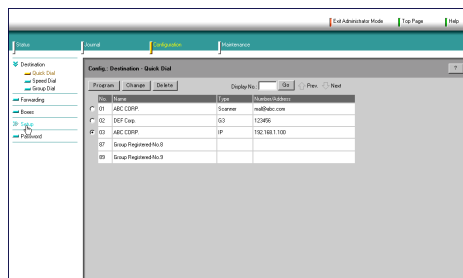

5 Enter the URL where the Help file (HTML file) is stored into the text box for **[Help URL]**, and then click **[Apply]**.

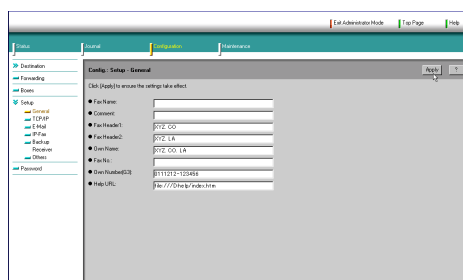

For example, if you created a folder named "help" in the D drive and you copied the Help file into the folder, enter "file:///D:/help/index.htm".

If the Help file is stored in the http server and open to public access, enter "http://(URL of the server that stores the Help file)/index.htm".

Note

- ❑ If you specify the saved Help file as "file:///", the **[Help]** button may not open Help (depending on the security settings of the operation system or Web browser). In this case, use the Web browser to locate the Help file directly, and then open "index.htm" to see Help.

6 Click **[Exit Administrator Mode]**.

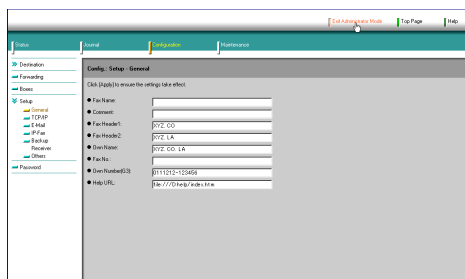

10. Troubleshooting

Error Messages

NIC FAX Display Messages

The following error messages appear on the display of NIC FAX when a problem occurs. If the advice provided below does not solve the problem, contact your service representative.

Message	Causes and solutions
Network Error 10-40	<ul style="list-style-type: none">• No fax IP address is set. Use NIC FAX control panel to set an IP address. See p.34 "IP Address".• Consult your network administrator.
Network Error 10-41	<ul style="list-style-type: none">• Multiple IP addresses are set. Use NIC FAX control panel to check that the IP address is correct. See p.34 "IP Address".• Consult your network administrator.
Network Error 10-45	<ul style="list-style-type: none">• DNS server's IP address is not registered. Check that the DNS server's IP address is correct using the Web browser. See p.153 "Making Settings through a Web Browser".• Consult your network administrator.
Network Error 10-46	<ul style="list-style-type: none">• Cannot find the DNS server. Check that the DNS server is correctly registered using the Web browser. See p.153 "Making Settings through a Web Browser".• Check that the LAN cable is correctly connected to NIC FAX. See p.25 "Connecting to a LAN".• Consult your network administrator.
Network Error 10-47	<ul style="list-style-type: none">• No IP address is provided by the DHCP server. Multiple IP addresses is found or the DHCP server canceled to provide an IP address. See p.32 "Network Boot".• Consult your network administrator.
Network Error 10-48	<ul style="list-style-type: none">• No DHCP server is found. Check the DHCP server is present on the network. See p.32 "Network Boot".• Check that the LAN cable is correctly connected to NIC FAX. See p.25 "Connecting to a LAN".• Consult your network administrator.
Network Error 10-56	<ul style="list-style-type: none">• No WINS server is found. Check that the WINS server is correctly registered using the Web browser. See p.153 "Making Settings through a Web Browser".• Consult your network administrator.
Network Error 10-57	<ul style="list-style-type: none">• Registering a host name to the WINS server failed. Check that the same host name is not used by other devices and the address of the WINS server is correct using the Web browser. See p.153 "Making Settings through a Web Browser".• Consult your network administrator.

Message	Causes and solutions
Network Error 10-60	<ul style="list-style-type: none"> • No POP server address is set. Check the POP server's host name/IP address is correct using the Web browser. See p.153 "Making Settings through a Web Browser". • Consult your network administrator.
Network Error 10-61	<ul style="list-style-type: none"> • POP server cannot be found. Check the POP server is correctly registered using the Web browser. See p.153 "Making Settings through a Web Browser". • Consult your network administrator.
Network Error 10-62	<ul style="list-style-type: none"> • Cannot log on to the POP server. Check the login name and password are correct using the Web browser. See p.153 "Making Settings through a Web Browser". • Try to log on to a POP server that does not support APOP when the APOP function is set to "On". Check that the POP server supports APOP. If it does not, change the setting with user parameters so APOP is not used. See p.28 "NIC FAX Initial Settings" and p.166 "User Parameters". • Consult your network administrator.
Network Error 10-70	<ul style="list-style-type: none"> • No SMTP server's IP address is set. Check the SMTP server's host name/IP address is correct using the Web browser. See p.153 "Making Settings through a Web Browser". • Consult your network administrator.
Network Error 10-73	<ul style="list-style-type: none"> • SMTP server cannot be found. Check the SMTP server is correctly registered using the Web browser. See p.153 "Making Settings through a Web Browser". • Consult your network administrator.
Network Error 10-74 12-18	<ul style="list-style-type: none"> • No e-mail address is set for NIC FAX. Check the e-mail address is set correctly using the Web browser. See p.153 "Making Settings through a Web Browser". • Consult your network administrator.
Network Error 10-88	<ul style="list-style-type: none"> • Cannot log on to the SMTP server when e-mail is transmitted using SMTP authentication. Check the account name and password are set correctly using the Web browser. See p.153 "Making Settings through a Web Browser". • Consult your network administrator.
Network Error 10-63 10-82 12-10 12-15	<ul style="list-style-type: none"> • A line error occurred while sending or receiving data. Check that the LAN cable is correctly connected to NIC FAX. See p.25 "Connecting to a LAN". • Consult your network administrator.

Message	Causes and solutions
Network Error 10-04 10-08 10-30 10-31 10-32 10-33 10-34 10-35	<ul style="list-style-type: none"> • A mechanical malfunction has occurred. Contact your service representative.
Network Error 12-50	<ul style="list-style-type: none"> • No delivery server IP address is set. Check that the delivery server's IP address is correctly registered using the Web browser. See p.153 "Making Settings through a Web Browser". • Consult your network administrator.
Network Error 12-51	<ul style="list-style-type: none"> • Cannot find the delivery server. Check the delivery server is correctly registered using the Web browser. See p.153 "Making Settings through a Web Browser". • Check that the LAN cable is correctly connected to NIC FAX. See p.25 "Connecting to a LAN". • Consult your network administrator.
Network Error 12-52	<ul style="list-style-type: none"> • Cannot log on to the delivery server. Check the delivery server is correctly registered using the Web browser. See p.153 "Making Settings through a Web Browser". • Check the LAN cable is correctly connected to NIC FAX. See p.25 "Connecting to a LAN". • Consult your network administrator.
Network Error 12-53	<ul style="list-style-type: none"> • The delivery server is not started up. Check the server is properly functioning. • Consult your network administrator.
Network Error 12-55	<ul style="list-style-type: none"> • An error occurred while sending data to the delivery server. Check the server is properly functioning. • Check that the LAN cable is correctly connected to NIC FAX. See p.25 "Connecting to a LAN". • Consult your network administrator.
Network Error 13-10	<ul style="list-style-type: none"> • Multiple alias fax numbers are set. Check that the alias fax number is correctly registered using the Web browser. See p.43 "IP-Fax Parameter Settings". • Consult your network administrator.
Network Error 13-11	<ul style="list-style-type: none"> • Cannot access the gatekeeper. Check that the gatekeeper address is correct using the Web browser See p.153 "Making Settings through a Web Browser". • Consult your network administrator.

Message	Causes and solutions
Short ID not found.	<ul style="list-style-type: none"> • The Short ID specified with the Network Delivery Scanner function is not found in the server. Specify the correct Short ID. See p.135 “Checking the Short ID of a Destination”. • The server is not started up, or temporarily inactive for reasons such as insufficient hard disc memory space. Check the condition of the server. If it is not working because hard disc memory space is insufficient, increase available memory space. • Consult your network administrator.

 **While Using the Network Delivery Scanner Function**

❖ **The Transmission to the Server Does Not Begin, Although Scanning of the Original Is Complete.**

When delivering a fax document using the Scanner function, NIC FAX transmits data after storing the document data in memory and then converting it into a file format. Consequently, it may take a while before transmission begins, depending on the number of originals.

❖ **An Error Occurred while a Transmission to the Server Was in Progress, or a Communication Failure Report Was Printed.**







Check if a network error message is shown on the display. If a message is shown, go through the table above to find out the causes and solutions for the message and solve the problem. If the server is not working because hard disk memory space is insufficient, increase available memory space.



 **Note**

- ❑ If the troubleshooting procedure takes a long time, you can select to temporarily terminate a transmission and print out the document using NIC FAX. See p.131 “Temporarily Terminating Fax Document Delivery”.
- ❑ If an error occurs while transferring a received fax document, the machine prints out a Communication Failure Report as well as the fax document, and then deletes the document data from memory. Check the contents of the printed documents, and then make a request to the sender to resend if necessary.

Web Browser Initial Display Messages

If any of the messages listed in the table below appear on the initial display of the Web browser, take appropriate action, following the instructions given.

Icons	Messages	Causes and solutions
	Network Communication Error	A LAN error has occurred. Check the message shown on the display.
	Fax Transmission Error	A communication error has occurred on the G3 line. See Chapter 4 "Solving Problems", <i>Basic Features</i> .
	No Paper	NIC FAX has run out of paper. Load paper. See Chapter 4 "Loading Paper in the Main Paper Tray", <i>Basic Features</i> . See Chapter 9 "Loading Paper in the Optional Paper Tray Unit" and "Loading Paper in the Bypass Tray", <i>Advanced Features</i> .
	Paper Misfeed	A paper jam has occurred in NIC FAX. Remove jammed paper. See Chapter 4 "Clearing a Copy, Fax or Print Jam", <i>Basic Features</i> . See Chapter 8 "Clearing a Paper Jam in the Optional Paper Tray Unit", <i>Advanced Features</i> .
	Original Misfeed: ADF	An original jam has occurred in NIC FAX. Remove the jammed original. See Chapter 4 "Clearing Original Jams", <i>Basic Features</i> .
	Cover Open	The cover of NIC FAX is open. Close it.
	No Toner Cartridge	Install the toner cartridge correctly. See Chapter 4 "Replacing the Toner Cartridge", <i>Basic Features</i> .
	No Toner	The toner has run out. Replace with a new one. See Chapter 4 "Replacing the Toner Cartridge", <i>Basic Features</i> .

Icons	Messages	Causes and solutions
	Toner Almost Empty	The toner level is low. Replace the toner cartridge before the toner runs out. See Chapter 4 "Replacing the Toner Cartridge", <i>Basic Features</i> .
	Call Service Center	Contact your service representative.

LAN-Fax Operation Messages

If one of the messages listed below appears on the Windows display, follow the instructions given here.

Message	Causes and solutions
Cannot connect to the printer. If you select [Retry] , the data will be sent to the printer again.	<ul style="list-style-type: none"> No destination is programmed under the specified Quick Dial, Speed Dial, or Group Dial code when using LAN-Fax transmission. Click [Cancel]. Specify a Quick Dial, Speed Dial, or Group Dial code which the destination is already programmed under and send the document again, or program the destination under the Quick Dial, Speed Dial, or Group Dial code. The memory limit was reached during a LAN-Fax transmission. Click [Cancel] to cancel the transmission, and then divide the document you want to send into parts for multiple transmissions. If there are any documents in memory waiting to be sent or printed with Substitute Reception, try to send the document again after transmission or printing of these is complete. Check the network connection. Check the power of NIC FAX is turned on.
The number of entries in Destinations exceed the limits. Up to 100 entries can be entered.	The number of destinations specified exceeds the limit. The maximum number of destinations that can be specified at one time is 100.
Up to 1500 characters can be entered. Please check.	The total number of characters used for the specified destinations exceeds the limit. The maximum number of characters that can be entered is 1500.
"LAN-Fax" has already been launched. Cannot launch it again.	The LAN-Fax dialog box is already open. Exit LAN-Fax once, and then start it up again.
Failed to allocate memory.	Available memory is insufficient.

Message	Causes and solutions
Device cannot be opened because there is no response from the device.	<p>This message appears when trying to display the Status List by double-clicking the icon of SmartDeviceMonitor for Client on the taskbar after installing and starting SmartDeviceMonitor for Client. Follow the procedure below after starting up SmartDeviceMonitor for Client to stop this message from appearing.</p> <ol style="list-style-type: none"> ① On the taskbar, right-click the icon of SmartDeviceMonitor for Client, and then click [Options]. ② In "Printer List", click [LAN-Fax F3]. ③ Click to clear the [To be Monitored] check box under "Monitoring Information Settings". ④ Click [OK]. <p> Reference p.46 "Quick Install" p.51 "SmartDeviceMonitor for Client"</p>

When Using Standard TCP/IP Port

When you use the LAN-Fax function on Windows 2000/XP, do not set "Standard TCP/IP Port" as the port for LAN-Fax Driver. Otherwise, the following limitations apply:

- The transmission result and printing result dialog boxes will not appear.
- If NIC FAX cannot print (such as when it is turned off or the cover is opened), and you save a file using the Saving function, the zero size file remains in the spooler. After a while, "There was an error found when printing the document "file://xxxxx" to IP_xxxxx. Do you want to retry or cancel the job?" message appears.

User Parameters

The user parameters allow you to customize various settings to match your needs.

Set the switches of each parameter to a new value to make changes to the settings.

 **Preparation**

Some user parameters require installation of optional equipment or operations such as turning a function on or off before changing the switch values. See Chapter 7 "User Parameters", *Advanced Features*.

❖ **Switches and Bits**

Each user parameter switch represents a bit (digit) of an eight-bit binary number. Each bit is referred to by its relative position, with bit 0 on the far right and bit 7 on the far left. Each bit can be either 0 or 1, and the status of each function is determined by the value of the corresponding bit.



	bit 7	bit 6	bit 5	bit 4	bit 3	bit 2	bit 1	bit 0
switch 16	0	0	0	1	0	0	0	0
			*5	*4	*3	*2		*1

- *1 Bits 0 and 1 determine if transmitted e-mail is retained on the server.
- *2 Bit 2 determines if ScanRouter V2 Lite is used.
- *3 Bit 3 determines if Error Mail Notification is sent.
- *4 Bit 4 determines if NIC FAX receives e-mail while the Night Timer is activated.
- *5 Bit 5 determines if received documents are forwarded to the ScanRouter V2 Professional server.

◆ User Parameter List

Switch	Bit	Item	Settings	Reference
16	1,0	Leave messages on POP server after receiving them.	00: No 01: Save all 10: Save only errors ⚠ Important <input type="checkbox"/> If you select "Save all" or "Save errors," periodically check your e-mail from a computer to remove messages from the POP server. 🚫 Limitation <input type="checkbox"/> You may not be able to save e-mail depending on the type of POP server.	⇒ p.88
2		Use ScanRouter V2 Lite	0: No 1: Yes 🚫 Limitation <input type="checkbox"/> If you select "Yes," the following limitations are applied to the fax features: <ul style="list-style-type: none"> • Destinations such as "#001" or "#002" cannot be specified as e-mail addresses because they are recognized as destinations programmed in the delivery server. • Some Reception features are not available. 	⇒ p.14 ⇒ p.19
3		If an error occurs during e-mail reception, send the Error Mail Notification to the sender.	0: Yes 1: No	⇒ p.172
4		Receive e-mail while the Night Timer is activated.	0: Yes 1: No	⇒ p.88
5		Condition for forwarding received documents to the ScanRouter V2 Professional server	0: Forward all documents 1: Only forward documents with Fax Delivering IDs	⇒ p.124

Switch	Bit	Item	Settings	Reference
17	0	SMTP Reception	0: Off 1: On	⇒ p.93
	1	Route documents received with SMTP	0: No 1: Yes	⇒ p.94
	2	Respond to requests to confirm the receipt of e-mail documents.	0: No 1: Yes	⇒ p.80
	4	Make a request for confirming reception when sending e-mail.	0: No 1: Yes	⇒ p.88
	5	Data format for scanned documents	0: TIFF-F (monochrome) / JPEG (color) 1: PDF	⇒ p.68
	6	Protocol for e-mail reception	0: POP3 1: IMAP4	⇒ p.28
18	0	Print LAN-Fax Error Report.	0: No 1: Yes	⇒ p.178
	1	Use APOP.	0: No 1: Yes	⇒ p.28
	2	Execute SMTP authentication.	0: No 1: Yes	⇒ p.28
	5	Transmit Journal.	0: No 1: Yes	⇒ p.80
	6	Access the POP server before accessing the SMTP server at the time of e-mail transmission.	0: No 1: Yes	⇒ p.28
	7	Print results of sending Reception Notice Request messages.	0: Print if the result is "E (Error)" 1: Print all	⇒ p.80

Switch	Bit	Item	Settings	Reference
32	0	Use gatekeepers at the time of IP-Fax transmission.	0: No 1: Yes  Note <input type="checkbox"/> If you change the setting to "Yes" or "No", register the destinations stored in Quick Dial keys or Speed Dials again. Otherwise, you will not perform the IP-Fax transmission correctly.	⇒ p.103
	1	Network Transmission Auto Check Function	0: Off 1: On  Note <input type="checkbox"/> If you select "On," network transmissions are automatically checked according to the setting made with switch 32, bit 0. If you select not to use the gatekeepers, IP addresses and host names are used for checking. If you select to use the gatekeepers, alias fax numbers are used for checking.	⇒ p.78 ⇒ p.100 ⇒ p.102 ⇒ p.103 ⇒ p.139 ⇒ p.143
33	1, 0	Adjustment of the image quality for Scanning of color originals (Brightness : Color Difference : Color Difference)	00: 4 : 1 : 1 01: 2 : 1 : 1 10: Disable 11: 1 : 1 : 1	⇒ p.61

The following table shows user parameter switches related to e-mail communications.

Switch	Bit	Item	Description
02	0	Forwarding mark printing	This setting specifies whether or not the forwarding mark should be appended to images of received e-mail when they are being forwarded or routed.
	1	Center mark printing	
	2	Reception time printing	
	3	TSI printing	Printing e-mail address in the From field of received e-mail
	4	Checkered Mark printing	

Switch	Bit	Item	Description
04	7	Attach images to File Reserve Reports, Transmission Result Reports, Communication Failure Reports, and Polling Transmission Clear Reports	This setting specifies whether or not a partial image of the transmitted document should be attached to the Transfer Result Report (Transmission Result Notification Mail) at the time of LAN-Fax transmission (if you set the user code in Options). See p.107 "Basic Transmission" and p.176 "Communication Result Report".
06	0	Fax Header printing	
	4	Batch transmission	E-mail transmission does not support batch transmission, but when you set to "On", the same e-mail is sent to multiple destinations at the same time (broadcasting). When you set to "Off", e-mail is sent to individual destinations one at a time (sequential broadcasting). See p.79 "When using NIC FAX with Broadcasting and Sequential Broadcasting".
10	1	Two In One	
	2	Image Rotation	
20	2	Selection of "Extra Super Fine" resolution for transmission	
	3	Selection of "Extra Super Fine" resolution for reception	

Reports and Lists

The formats of most reports and lists printed while you are using the Internet Fax or LAN-Fax features are identical to those printed for the standard fax functions. This section describes important reports and lists that have different formats.

Note

- ❑ See the Advanced Features manual for information about the reports and lists not described in this section. Note that e-mail addresses are printed in place of fax numbers to indicate the e-mail transmission addresses in those reports and lists.

Transfer Result Report

When NIC FAX receives a transfer request by e-mail, the Transfer Result Report is sent by e-mail to the requesting party after completing all transmissions to the specified Transfer Stations.

```
***** MAIL INFORMATION ***** 15. APR. 2003 17:14 *****
From: nicfax@abc. company. com
Subject: From "0123456789" ("ABC. COMPANY") (Fax Message NO. 9407)
*****

***** TRANSFER RESULT REPORT ( 2003. 4.15 17:14 ) *****

TRANSFER STATION      nicfax@abc. company. com
TRANSFER REQUESTED TIME 4.15 17:13

ADDRESS (GROUP)                PAGE    RESULT
-----
Mail : nicfax@ccc. company. com      1      --
G3  : 212-123-4567                   1      OK
```

ZHMX110E

◆ RESULT

Describes results of transmissions.

OK	Indicates all pages of the fax document were successfully transmitted.
Error	Indicates the transmission was not successful.
--	Indicates the fax document was successfully transmitted to the e-mail server registered to NIC FAX using the Internet Fax Transmission feature. (It does not indicate the e-mail reached the receiver.)

Error Mail Notification

NIC FAX sends the Error Mail Notification to the sender when it is unable to successfully receive a particular e-mail message. A "cc" of this notification is also sent to the administrator's e-mail address when one is specified.

Note

- You can select to send Error Mail Notification with user parameters. See p.166 "User Parameters" (switch 16, bit 3).
- If Error Mail Notification cannot be sent, the Error Report (Mail) is printed by NIC FAX.
- If an error occurs when an e-mail is received via SMTP, the SMTP server sends an error e-mail to the originator of the message.

Reference

p.41 "Backup Mail TX (Backup Mail Transmission)"

p.173 "Error Report (Mail)"

p.166 "User Parameters"

```
***** MAIL INFORMATION ***** 15. APR. 2003 17:17 *****
```

```
From: nicfax@abc. company. com
Subject: From " 0123456789" (" ABC. COMPANY") (Error Message NO. 9410)
```

```
*****
```

```
***** ERROR MAIL NOTIFICATION (2003. 4.15 17:16) *****
```

```
NOTIFICATION FROM          nicfax@abc. company. com
```

```
CAUSE OF ERROR:   INVALID FILE (DECODE ERROR)
```

```
PLEASE CONFIRM
```

```
THANK YOU
```

ZHMX120E

Error Report (Mail)

The Error Report (Mail) is printed by NIC FAX when it is unable to send an Error Mail Notification.

* * * ERROR REPORT (MAIL) (15.APR. 2003 17:20) * * *		P.1
		FAX HEADER 1: ABC.COMPANY
		FAX HEADER 2: DESIGN
FILE TIME	ADDRESS	

9413 17:19	✦ :nicfax@ abc.company.com	
PLEASE SEND THIS REPORT TO THE ABOVE ADDRESS.		
REASON FOR ERROR: INVALID FILE (DECODE ERROR)		

ZHMX130E

Server-Generated Error E-mail

The transmitting server sends this error e-mail to the originator of e-mail that cannot be transmitted successfully (due to reasons such as specifying an incorrect e-mail address).

 **Note**

- After a server-generated error e-mail is printed, the first page of the sent document is printed.

Journal

 **Note**

- The Journal is automatically printed out after each 50 transmissions and/or receptions. You can also print it out manually. See Chapter 2 "Printing the Journal", *Advanced Features*.

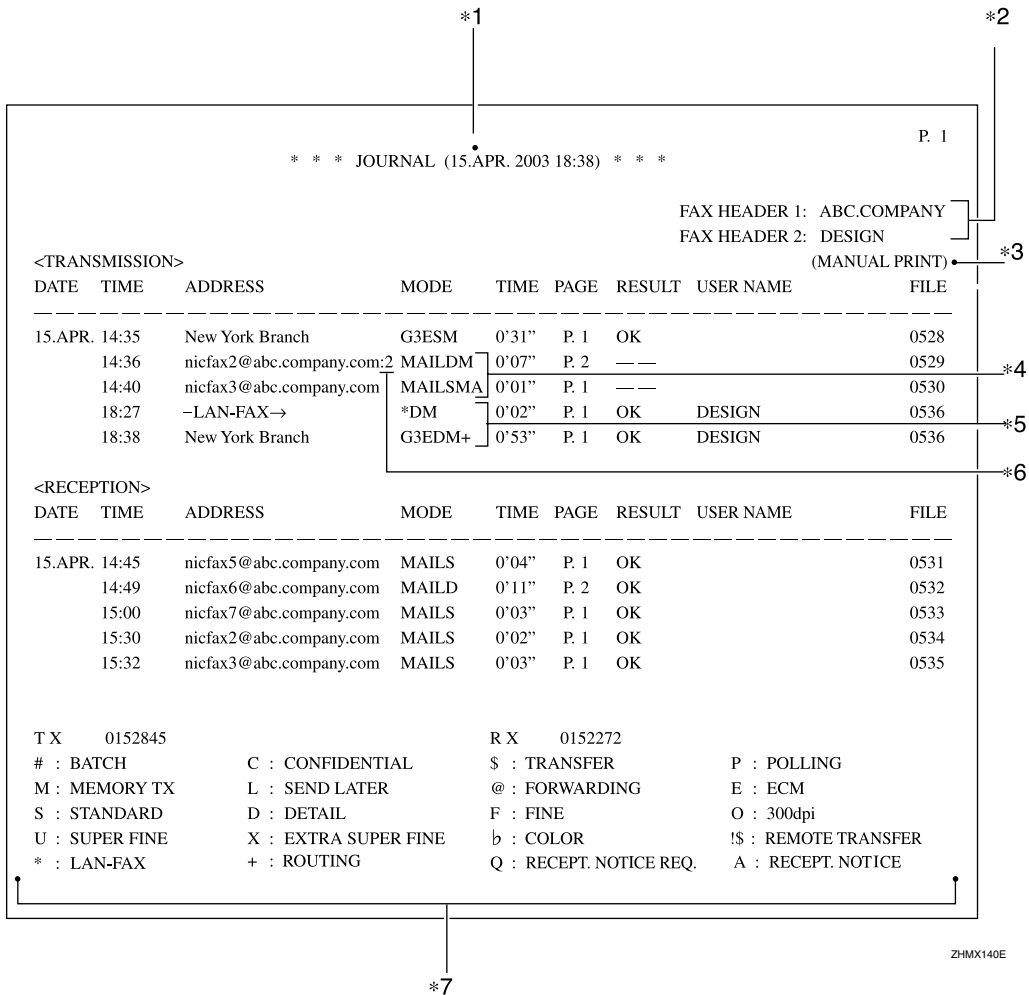

1. DATE

Date of transmission or reception

2. TIME

Time transmission or reception started

3. ADDRESS

In the case of e-mail transmission, this column shows the address that was entered manually, or the name assigned to the specified Quick Dial or Speed Dial code. In the case of e-mail reception, this column shows the address that appeared in the From field of the received e-mail. In the case of communication with another fax machine, this column shows the other party's fax number or registered name.

4. MODE

A letter or symbol indicates the adopted communication mode.

The letter "Q" appears next to e-mail for which Confirm Reception was specified in "Mail Options". The letter "A" appears next to e-mail for which Receipt Notifications have been sent.

5. TIME

Time elapsed during transmission or reception. If the elapsed time exceeds 99 minutes and 59 seconds, **' **' is printed .

6. PAGE

Number of pages of the transmitted or received documents. If the number of pages exceeds 999, ** is printed.

7. RESULT

Describes results of transmission or reception.

OK	Indicates all pages of the fax document were successfully transmitted. When e-mail is specified for Reception Confirmation in "Mail Options", and a reception confirmation message has been received from the receiver, "OK" is displayed.
E	Indicates the transmission was not successful. Also indicates e-mail is not being received normally. See p.80 "Confirming Reception".
--	Indicates the fax document was successfully transmitted to the e-mail server registered to NIC FAX by using the Internet Fax Transmission feature. (It does not indicate the e-mail reached the receiver.)
D	Power outage occurred during communication. Part of the document was not successfully transmitted.

8. USER NAME

The user name is printed with User Code Transmission, or if Restricted Access is activated

9. FILE

File number (document control number)

- *1: Data and time of printing
- *2: Names registered as Fax Header 1 and Fax Header 2
- *3: Printed when the report is manually printed
- *4: E-mail transmission
- *5: LAN-Fax transmission
- *6: Broadcasting transmission
- *7: Meaning of the symbols shown in MODE

Box List

*1 *2

* * * BOX LIST (15.APR. 2003 18:31) * * *

P. 1

FAX HEADER 1: ABC.COMPANY
FAX HEADER 2: DESIGN

BOX NAME	MODE	SUB/SEP [SID/PWD]	PROGRAMMED RECEIVER
DESIGN	PERSONAL BOX	1111 []	<input type="checkbox"/> 15 <input type="checkbox"/> : design@abc.comp any.com
ABCD	PERSONAL BOX	2222 [4444]	
PRODUCT	TRANSFER BOX	3333 []	<input checked="" type="checkbox"/> 100 G3 : 1234567 (G1) North America

ZHMX150E

1. BOX NAME

The Personal/Transfer Box names registered in NIC FAX are printed.

2. MODE

"PERSONAL BOX" or "TRANSFER BOX" is printed.

3. SUB/SEP [SID/PWD]

The SUB or SEP code specified to each registered Box is printed. If a password is registered, it is printed in the bracket.

*1: Data and time of printing

*2: Names registered as Fax Header 1 and Fax Header 2

4. PROGRAMMED RECEIVER

Receivers set for Personal Boxes and End Receivers set for Transfer Boxes are printed. indicates a Quick Dial destination, indicates a Speed Dial destination, indicates an e-mail address, and "G*" indicates a Group Dial destination.

Communication Result Report

When a fax is sent, a Communication Result Report is sent to the destination if the routing destination's e-mail address is specified using a programmed user code. This makes it possible to verify the result of a transmission.

A Communication Result Report is also transmitted when you specify a user code and send a fax or e-mail using the Scanner function, Internet Fax function, or LAN-Fax function.

Note

- You can have the transmitted document attached to the Transmission Result Report with user parameters. See p.166 "User Parameters" (switch 04, bit 7).

- ❑ To have digits or characters appear correctly in the report mail, specify a fixed-width font in the Properties settings for the Mail application on your computer.
- ❑ If all transmissions are successful, the subject of the Communication Result Report begins with "Transmission Result:OK". Even if one transmission fails, the subject of the Communication Result Report begins with "Transmission Result:Error".

Reference

p.68 "Scanning a Monochrome Original"

p.73 "Using Internet Fax Functions"

p.99 "Using IP-Fax Functions"

p.107 "Using LAN-Fax Functions"

```

***** MAIL INFORMATION ***** 15.APR. 2003 17:17 *****
From: nicfax@abc.company.com
Subject: From "0123456789" ("ABC. COMPANY") (Error Message NO. 9407)
*****

***** COMMUNICATION RESULT REPORT( 2003. 4.15 17:16 ) *****

TRANSFER STATION          nicfax@abc.company.com
TRANSFER REQUESTED TIME   4.15 17:15

ADDRESS(GROUP)            PAGE RESULT
-----
Mail :nicfax@ccc.company.com          1/ 1 --

-----
REASON FOR ERROR
E-1) HANG UP OR LINE FAIL           E-2) BUSY
E-3) NO ANSWER                     E-4) NO FACSIMILE CONNECTION
E-5) MAIL SIZE OVER

```

ZHMX160E

RESULT

Indicates the results of transmissions.

OK	Indicates all pages of the document were successfully transmitted.
E	Indicates the transmission was not successful. After "E", a number showing the reason for the error is printed.
--	Indicates the fax document was successfully transmitted to the e-mail server registered to the machine. (It does not indicate the e-mail reached the receiver.)

LAN-Fax Error Report

The LAN-Fax Error Report is printed if the settings for options are not correct or an error occurs during communication with the computer when the LAN-Fax function is used.

 **Note**

- You can select whether the LAN-Fax Error Report is printed with user parameters. See p.166 “User Parameters” (switch 18, bit 0).

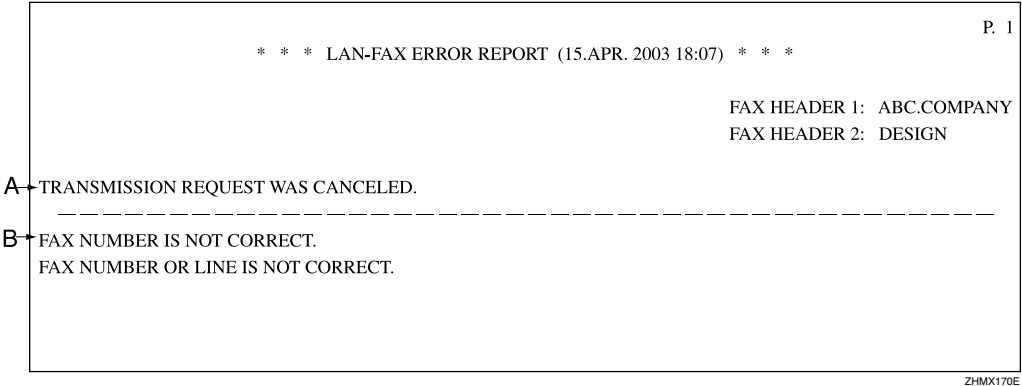

❖ Error Messages

One of the following types of error messages is printed on the LAN-Fax Error Report, according to the cause of the error.

Error messages consist of two parts ("A" and "B" respectively in the table below).

Type	Error Messages	
1	A	LAN-FAX ERROR. THIS FILE HAS NOT BEEN STORED.
	B	EXCEEDED MAXIMUM FILE CAPACITY. EXCEEDED MAXIMUM NUMBER OF PAGES PER FILE.
2	A	TRANSMISSION REQUEST WAS CANCELED.
	B	YOU CANNOT SPECIFY DESTINATION NOW.
3	A	TRANSMISSION REQUEST WAS CANCELED.
	B	FAX NUMBER IS NOT CORRECT. FAX NUMBER OR LINE IS NOT CORRECT.
4	A	ERROR DURING COMMUNICATION WITH PC.
	B	–
5	A	TRANSMISSION REQUEST WAS NOT ACCEPTED.
	B	YOU ARE NOT AUTHORIZED TO ACCESS THIS.

Journal by E-mail

If the setting is made so that the Journal is transmitted as e-mail, it is transmitted to the e-mail address of an administrator.

This section describes the CSV format of the Journal attached with e-mail.

Important

- It is recommended that you double-check the e-mail address of an administrator before the Journal is transmitted. If the e-mail address of the administrator is not correct, your important Journal may be lost and sent CSV file is not left on NIC FAX.

Note

- To transmit the Journal, it is necessary to make settings with user parameters. See p.166 "User Parameters"(switch 18, bit 5).

Reference

To set the administrator e-mail address, see p.40 "Mail to Admin. (Mail to Administrator)".

Transmission										
Date	Time	Name	Type	Option	Time	Page(s)	Result	User Name	File No.	
[5.DEC.]	[10:23]	[New York Branch]	[G3]	[ECM/Standard/Memory Trans.]	[0'15"]	[P. 1]	[OK]	DESIGN	[001]	
[5.DEC.]	[12:09]	[--LAN-FAX--]	[LAN-FAX]	[Detail/Memory Trans.]	[0'01"]	[P. 1]	[OK]		[003]	*2
[5.DEC.]	[12:09]	[04511112222]	[G3]	[Detail/Memory Trans./Routing]	[0'03"]	[P. 1]	[--]		[003]	
[5.DEC.]	[15:09]	[nicfax2@abc.company.com]	[Mail]	[Standard/Memory Trans.]	[0'02"]	[P. 1]	[--]		[007]	*3
[5.DEC.]	[15:12]	[nicfax3@abc.company.com]	[Mail]	[Standard/Memory Trans.]	[0'02"]	[P. 1]	[--]		[008]	

Reception										
Date	Time	Name	Type	Option	Time	Page(s)	Result	User Name	File No.	
[5.DEC.]	[9:34]	[New York Branch]	[Mail]	[Detail]	[0'14"]	[P. 2]	[OK]		[002]	
[5.DEC.]	[12:59]	[nicfax4@abc.company.com]	[Mail]	[Standard]	[1'32"]	[P.10]	[OK]		[004]	
[5.DEC.]	[13:19]	[nicfax5@abc.company.com]	[Mail]	[Standard]	[1'12"]	[P.10]	[OK]		[005]	
[5.DEC.]	[14:05]	[nicfax6@abc.company.com]	[Mail]	[Standard]	[0'20"]	[P. 3]	[OK]		[006]	
[5.DEC.]	[15:27]	[nicfax7@abc.company.com]	[Mail]	[Standard]	[0'15"]	[P. 2]	[OK]		[009]	

*1

ZHMX180E

1. Date

Date of transmission or reception

2. Time

Time transmission or reception started

3. Name

Sender or receiver name

4. Type and Option

Type of line and communication mode

5. Time

Time elapsed during transmission or reception. If the elapsed time exceeds 99 minutes and 59 seconds, '**:*"' is printed.

6. Page

Number of pages of the transmitted or received documents. If the number of pages exceeds 999, P. ** is printed .

7. Result

Result of transmission or reception

OK	Indicates all pages of the fax document are successfully transmitted. When e-mail is specified for Reception Confirmation in "Mail Options", and a reception confirmation message has been received from the receiver, "OK" is displayed.
E	Indicates the transmission was not successful. Also indicates the e-mail is not normally received. See p.80 "Confirming Reception".
--	Indicates the fax document was successfully transmitted to the e-mail server registered to the machine using the Internet Fax Transmission feature. (It does not indicate that the e-mail reached the receiver.)
D	Power outage occurred during communication. Part of the document was not successfully transmitted.

8. User Name

The user name is printed with User Code Transmission or if Restricted Access is activated.

9. File No.

File number (document control number)

*1: Each transmission and reception result is shown.

*2: These are LAN-Fax transmission results.

*3: These are Scan to E-mail transmission result.

Specifications

Network	LAN : Local Area Network (Ethernet/10Base-T, 100Base-TX)
Transmit function	E-mail
Scan line density	<ul style="list-style-type: none"> • Internet Fax feature Standard (200 × 100 dpi), Detail (200 × 200 dpi) • IP-Fax feature Standard (200 × 100 dpi), Detail (200 × 200 dpi), Super Fine (400 × 400 dpi), Extra Super Fine (600 × 600 dpi) • Scanner feature Standard (Monochrome: 200 × 100 dpi, Color: 100 × 100 dpi), Detail (200 × 200 dpi), 300dpi (300 × 300 dpi), Super Fine (400 × 400 dpi), Extra Super Fine (600 × 600 dpi)
Document size (Original size : Scanning width)	<ul style="list-style-type: none"> • Internet Fax feature A4 : 216 mm (8.5 in.) (Originals larger than A4 size is reduced in size when transmitted.) • IP-Fax feature A4 : 216 mm (8.5 in.) • Scanner feature A4 : 210 mm (8.3 in.)
Transmit protocols	<ul style="list-style-type: none"> • E-mail Transmission SMTP, TCP/IP • E-mail Reception POP3, SMTP, IMAP4, TCP/IP • IP-Fax T.38 Annex B, TCP, UDP/IP • Network Delivery Scanner FTP, TCP/IP
E-mail format	Single/Multi-part, MIME Conversion Attached file forms: TIFF-F (MH compression), JPEG (Transmission only), PDF (Transmission only), DCX (Reception only)
Compatible models	Machines that are equipped with NIC FAX Kit Type 500/210/140 and NIC FAX UNIT TYPE410
Internet communication	<ul style="list-style-type: none"> • Internet Fax Send and receive e-mail with a computer that has an e-mail address • IP-Fax Communicates with gatekeepers and converts fax numbers to IP addresses to transmit documents.
E-mail send functions	Automatic conversion of sent documents to e-mail format and e-mail transmission. Memory transmission only.
E-mail receive functions	Automatic detection and printing of appended TIFF-F (MH) files and ASCII text. Memory reception only.

IP-Fax transmission functions	Transmits fax documents to IP-Fax compatible fax machines via a network by specifying IP addresses. You can also transmit fax documents to G3 fax machines connected to public telephone line via a VoIP gateway.
IP-Fax reception functions	Receives fax documents sent from IP-Fax compatible fax machines via a network. Also can receive documents sent from a G3 fax machine connected to the public telephone line via a VoIP gateway.
LAN-Fax transmission functions	Transmits documents made using an application on the computer as fax documents from NIC FAX connected to a network. You can use NIC FAX as a printer to print those documents.
Scan to E-mail functions	Converts scanned documents to image files, and transmits them as attachments to e-mail. Transmission of color originals is also possible.
Network Delivery Scanner functions	Delivers scanned documents to destinations in the ScanRouter V2 Lite server, or ScanRouter V2 Professional server.

Received Images

Here is an example of a fax message sent from NIC FAX and received on a computer using Outlook e-mail software.

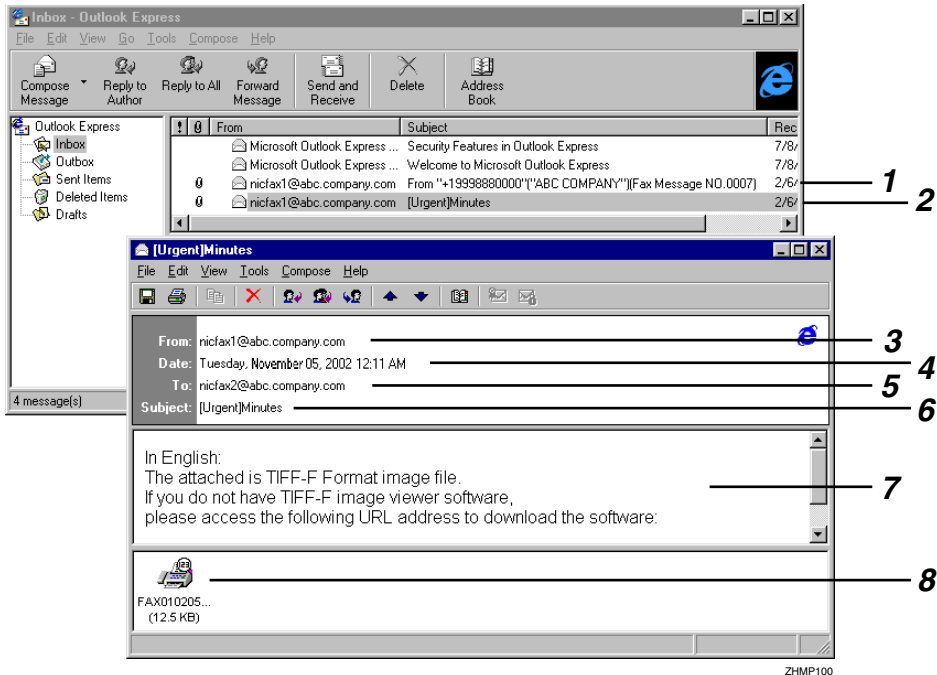

1. Mail transmitted without specifying a subject and priority in "Mail Options".

2. Mail transmitted with a subject and priority specified in "Mail Options".

3. From

The name (e-mail address) of the sender

4. Date

The date and time of e-mail transmission

5. To

The e-mail address of the recipient

6. Subject

Shows the priority and subject specified in "Mail Options" at the time of transmission. If no subject is specified, one is automatically assigned in the format shown in 1 above. From "Own Fax Number" ("Own Name") (Fax Message NO. document number)

Note

The format varies according to whether the e-mail was sent using user codes and other settings. See p.79 "About the E-mail Subject".

7. Viewer URL Information

If you select "Yes" for the "Add Viewer URL" mail option, sites from which viewer applications can be downloaded are included in the e-mail.

8. Attachment File

Any message included by the sender is displayed as an attached document.

View it using DeskTopBinder Lite.

INDEX

100BASE-TX Cable, 25
10BASE-T Cable, 25

A

Access Control, 36
Access Mask, 37
Account Name, 39
Address Book, 56, 110
Advanced Features, 3
After the Original Has Been Scanned In, 96, 105
Alias Fax Number → Own Fax Number, 44
APOP, 31
Appendix, 171
Assigning User Function Keys, 25
Authorized E-mail Reception, 42
Authorized Reception, 9
Auto Mail Reception, 23, 25, 43, 88
Auto-run Program, 46

B

Backup Mail Transmission, 41
Basic Features, 3
Basic LAN-Fax Transmission, 107
Basic Transmission, 107
Batch Transmission, 6, 8, 11, 16
Before Using Network Functions, 25
Before You Use This Machine, 3
Box List, 176
Broadcasting and Sequential Broadcasting, 79

C

Canceling Transmission of an Internet Fax, 96
Canceling Transmission of an IP-Fax, 105
Chain Dial, 6, 8, 16
Color Original, 117
Communication Result Report, 176
Compatible Models, 181
Confidential Reception, 9
Confidential Transmission, 6, 8, 16
Confirmation of Reception, 62, 68, 74
Confirming Reception, 80
Connecting from your Computer, 153
Connecting to a LAN, 25
Control Panel, 23

D

Deleting Template Addresses, 148
Deleting Template Subjects and Messages, 151
Delivering Scanned Data, 117
DeskTopBinder Lite, 53, 58
Dialing with the Dial Option Key, 6, 8, 16
Display Area, 155
DNS, 36
DNS Address 1, 36
DNS Address 2, 36
Document Size, 181
Domain Name, 35

E

ECM, 8
ECM (Error Correction Mode), 6, 16
E-mail Addresses, Registering, 133
E-mail Format, 181
E-mail Message, 23, 26
E-mail Receive Functions, 181
E-mail Send Functions, 181
E-mail Server Settings, 73
E-mail Server Settings
 (by Network Administrator), 73
E-mail Servers That Have
 Been Confirmed to Work, 73
End Receiver, 82
Error Mail Notification, 172
Error Messages, 159
Error Report (Mail), 173

F

Fax Document Delivery Settings, 122
Fax Header, 6, 16
FAX Utilities, 46
Forwarding Received Documents, 92
Functions Not Supported by E-mail Reception, 9
Functions Not Supported
 by E-mail Transmission, 8
Functions Not Supported
 by IP-Fax Transmission, 11
Functions Not Supported
 by Network Delivery Scanner, 16
Functions Not Supported by Scan to E-mail, 6
Functions Not Supported by Scan to
 Network Delivery Scanner, 16
Functions You Can Check or Set Up, 156

G

Gatekeeper, 11
Gatekeeper Address, 44
Gateway Address, 35
Getting Started, 23

H

Header Area, 155
Heading, in E-mail, 62, 68, 74
Help, 157
【★】key, 24
Host Name, 35
How to Read This Manual, 2, 17
Hub, 25

I

ID Reception, 9
ID Transmission, 8
IMail Server for Windows NT, 73
Immediate Transmission, 8
 Memory Transmission, 6, 16
Initial Display, 43, 154
Initial Settings, 28
Installing the Driver and Utilities, 48
Installing the Driver
 and Utilities Individually, 48
Installing the Software, 46
Internet Communication, 181
Internet FAX, 23, 26
Internet Fax, 7, 73
Internet Fax Functions, 7
Internet Fax Precautions, 8
Internet Fax, Transmitting, 74
Introduction, 5
IP Address, 34
IP-Fax, 10, 99
IP-Fax Functions, 10
IP-Fax Parameter Settings, 43
IP-Fax Precautions, 11
IP-Fax, Transmitting, 100

J

JBIG Transmission, 6, 8, 16
Journal, 173
Journal by E-mail, 179
Journal by E-mail, Transmitting, 80
JPEG, 5, 23, 26

K

Key Layout, 23

L

Label Insertion, 6, 16
LAN Cable, 25
LAN-Fax, 12, 107
LAN-Fax Cover Sheet Editor, 57
LAN-Fax Driver, 48, 56
LAN-Fax Error Report, 178
LAN-Fax Functions, 12
LAN-Fax Operation Messages, 164
LAN-Fax Precautions, 12
LAN-Fax Properties, Setting, 114
List of Files, 55

M

Mail Address, 39
Mail Options, 23, 26
Mail Reception, 23, 26
Mail Reception Interval, 40
Mail Server Settings, 38, 73
Mail to Administrator, 40
Making Settings
 through a Web Browser, 22, 153
Managing Transmissions
 from LAN-Fax Driver, 109
Manual Dial, 6, 8, 11, 16
Manual Mail Reception, 88
Manuals for This Machine, 3
Maximum Mail Size, 41
Memory File Transfer, 6, 8, 11, 16
Memory Lock Reception, 9
Menu Area, 155
MIME, 7, 181
Monochrome Original, 118
Multi-copy Reception, 9

N

Necessary Operation Manuals, 18
Netscape Messaging Server, 73
Network, 181
Network Administrator, 73
Network Boot, 32, 37
Network Delivery Scanner, 13
Network Delivery Scanner Functions, 13
Network Settings, 33
NIC FAX Display Messages, 159
NIC FAX Driver, 46
NIC FAX Initial Settings, 28
NIC FAX Unit CD-ROM Manual, 3
NIC FAX Unit Manual
 (on CD-ROM) (this manual), 3

O

On Hook Dial, 6, 8, 16
Online Help, 60, 157
Overview of Setting Up and Delivering Data, 19
Own Fax Number, 44

P

Password, 39
PDF, 5
Polling Reception, 6, 9, 16
Polling Transmission, 6, 8, 16
POP before SMTP, 31
POP Server, 38
Post.Office, 73
Precautions for Reading
 Instructions and Online Help, 21
Printing, 112
Printing and Saving, 112
Proxy Server, 154

Q

Quick Install, 46

R

Received Images, 183
Receiving E-mail with
 the Job Information Function, 89
Receiving E-mail with
 the Mail Reception Function, 89
Receiving Internet Fax, 88
Receiving Transfer Request E-mail, 90
Reception Confirmation, 62, 68, 74, 80
Refresh Button, 155
Registering Addresses, 133
Registering Addresses for Internet Faxing, 137
Registering Addresses for IP-Faxing, 141
Registering Addresses for Scanner, 133
Registering/
 Editing a Destination, 133, 137, 141
Registering Template Addresses, 147
Registering Template
 Subjects and Messages, 149
Reports and Lists, 171
Resolution key, 23
Routing Mail Received via SMTP, 94
Routing Received Documents, 91
Routing Received Fax Documents, 122

S

Saving, 112
Scan Line Density, 181
Scanner, 23, 27
Scanner RGB, 66
Scanner Server, 42
Scanning a Color Original, 61
Scanning a Monochrome Original, 68
ScanRouter V2 Lite, 19, 54, 59
ScanRouter V2 Lite Server, 14
ScanRouter V2 Professional, 20, 122
ScanRouter V2 Professional Server, 15
Scan to E-mail, 5, 23, 27
Scan to E-mail Functions, 5
Seattle Lab Mail Server, 73
Sendmail/QUALCOM Pop Server, 73
SEP Code Polling Reception, 6, 9, 16
Server-Generated Error E-mail, 173
Setting LAN-Fax Properties, 114
Setting Up and Delivering Data, 19
Setting up ScanRouter V2 Professional, 122
SmartDeviceMonitor for Admin, 52, 58
SmartDeviceMonitor for Client, 51, 57
SMTP authentication, 31
SMTP Reception, 93
SMTP Server, 38
Software Included on the CD-ROM, 55
Specifications, 181
Specified Tray, 9
Specifying by Groups (Group Code), 120
Specifying by Groups (Quick Dial), 120
Specifying by Redial, 120
Specifying Destinations Without
 Using Quick Dial Keys or Speed Dials, 120
Specifying End Receivers, 86
Specifying Mail Transfer, 95
Specifying Using the Number Keys, 121
SUB Code Transmission, 6, 8, 16
Subject and Message, 61, 68
Subject and Message, in E-mail, 74
Subject, in E-mail, 79
Subnet Mask, 35
Switches and Bits, 166
System Requirements, 153

T

- TCP/IP Settings, 34
- Template Subject, 43
- Template Subjects and Messages, Registering, 149
- Temporarily Terminating Fax Document Delivery, 131
- TIFF-F, 5, 7
- Time Zone, 40
- Transfer Request, 82
- Transfer Request by E-mail, 84
- Transfer Requester, 82
- Transfer Request Transmission, 6, 16
- Transfer Result Report, 171
- Transferring Received Documents, 91
- Transfer Station, 82
- Transmission End Operation, 126
- Transmission Using the Backup File Transmission Feature, 129
- Transmit Function, 181
- Transmit Protocols, 181
- Transmitting by
 - Specifying an Alias Fax Number, 103
- Transmitting by Specifying an IP Address or Host Name, 100
- Transmitting by Specifying a VoIP Gateway, 101
- Transmitting Internet Fax, 74
- Transmitting IP-Fax, 100
- Transmitting Journal by E-mail, 80
- Troubleshooting, 159

U

- User Code, 79
- User Function Keys, 23, 25
- User Parameters, 166
- Using Internet Fax Functions, 73
- Using IP-Fax Functions, 99
- Using LAN-Fax Functions, 107
- Using Network Delivery Scanner Functions, 117
- Using Online Help, 157
- Using ScanRouter V2 Lite Server, 14
- Using ScanRouter V2 Professional Server, 15
- Using Scan to E-mail Functions, 61

V

- Viewer URL Information, 68, 74
- VoIP, 11

W

- Web Browser, 22
- Web Browser Initial Display Messages, 163
- Web Browser Settings, 157
 - Administrator Mode*, 155, 157
 - Functions You Can Check or Set Up*, 156
- What Do You Want to Do with This Machine?, 1
- While the Original Is Being Scanned In, 105
- While the Original is Being Scanned In, 96
- WINS Server, 33
- WINS Server Address
 - WINS Server*, 37



Declaration of Conformity

“The Product complies with the requirements of the EMC Directive 89/336/EEC and the Low Voltage Directive 73/23/EEC and 93/68/EEC.”

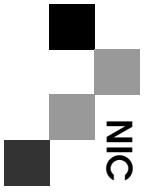

NIC FAX UNIT TYPE410 Operating Instructions



NIC FAX UNIT CD-ROM

Operating Instructions



TABLE OF CONTENTS

Introduction 1
Trademarks.....2
How to Read Documents on the CD-ROM3
System Requirements4
Important5
Using the CD-ROM.....6
Settings and Installation7

Introduction

Thank you for purchasing NIC FAX.

You are requested to read through and agree with the terms and conditions of the User License Agreement before using NIC FAX Driver and Utilities and NIC FAX Unit manual.

This CD-ROM contains the following:

❖ **NIC FAX Driver and Utilities**

- LAN-Fax F3 (LAN-Fax Driver)
- Address Book
- LAN-Fax Cover Sheet Editor
- SmartDeviceMonitor for Client / Admin
- DeskTopBinder Lite
- ScanRouter V2 Lite

❖ **Online Help**

- Online Help for using a Web browser

❖ **NIC FAX Unit Manual**

- NIC FAX UNIT TYPE410 Operating Instructions
- Server Domain Authentication

❖ **Adobe Acrobat Reader**

Trademarks

Adobe, the Adobe logo, and Adobe Acrobat are registered trademarks of Adobe Systems Incorporated.

Microsoft®, Windows®, Windows NT® are registered trademarks of Microsoft Corporation in the United States and/or other countries.

Pentium is a registered trademark of Intel Corporation.

Other product names used herein are for identification purposes only and might be trademarks of their respective companies. We disclaim any and all rights to those marks.

How to Read Documents on the CD-ROM

The manual on this CD-ROM is in PDF format. To read it, you must install Adobe Acrobat Reader on your computer.

System Requirements

You need the following when using Quick Install to run NIC FAX Driver and Utilities, and to read NIC FAX Unit manual. (For detailed information about each utility and driver, refer to the specific Readme files.)

Computer	: IBM PC/AT or compatible running Windows 95, Windows 98, Windows Me, Windows NT 4.0, Windows 2000, Windows 2003 Server or Windows XP
CPU	: 133-MHz Pentium (or a CPU that satisfies the minimum requirements of your operating system)
Free Memory	: 32 MB minimum (or a size that satisfies the minimum requirements of your operating system)
Disk Space	: 16 MB minimum
Operating System	: Windows 95, Windows 98, Windows Me, Windows NT 4.0, Windows 2000, Windows 2003 Server or Windows XP

Important

Operation cannot be guaranteed for all system configurations. In no event will the company be liable for direct, indirect, special, incidental, or consequential damages as a result of handling or operating the machine (hardware/software) and NIC FAX Driver and Utilities/NIC FAX Unit manual.

Using the CD-ROM

Before using the CD-ROM, please make sure that Adobe Acrobat Reader is installed on your computer.

- 1** Start up the computer.
- 2** Insert the CD-ROM into the CD-ROM drive.
- 3** Select the language you want, then click [OK].
- 4** Click [Browse This CD-ROM] on the Printer Drivers and Utilities screen, or open the following folder.
D:\Manual\English
(If your CD-ROM is assigned to drive D.)
- 5** Double-click the "NIC FAX.pdf" file to view it.

Settings and Installation

- ① Adjust the NIC FAX Settings. For details, see Chapter 2 "Before Using Network Functions", "NIC FAX Initial Settings" and Chapter 4 "E-mail Server Settings", *NIC FAX Unit manual*.
- ② Install the NIC FAX Driver and Utilities. For details, see Chapter 2 "Installing the Software", *NIC FAX Unit manual*. This section should be printed out for reference.



NIC FAX UNIT CD-ROM Operating Instructions

Printed in China

GB **GB**

AE **AE** H231-8603C